

sentiotec

SAUNA & SPA



MY WORLD OF WELL-BEING.

FROM SAUNA CONTROLS TO WELLNESS ACCESSORIES:

Wellness is a well-rounded affair. As a full-service supplier for every part of the spa area – from the sauna to infrared lighting and steam baths – we supply compelling solutions that satisfy individual expectations. We rely on in-house development and production to guarantee the highest standards of quality.

In these fast-paced times, it is increasingly important to take time off and relax. Our innovative products give you the chance to get back to the essentials – an all-round wellness experience that you can enjoy. You don't need to worry about the technology or how to implement it. That's the service we offer.

sentiotec together with its parent company Harvia, is the market leader for sauna, infrared and steam baths in Central Europe.

sentiotec stands for excellent product design and technological advance.

THE WELLNESS OF TOMORROW:

Starting with innovations in electronic control units for sauna cabins through to supplying the full range of products for spa areas – we have a clear commitment to research and development, exacting design standards, highly efficient production and a total focus on the customer. We are looking to the future with fresh energy and a clear mission – thanks to our unique range of services for a constantly growing market.

Our mission:

One-stop-shop: We supply our customers with EVERYTHING they need to successfully conclude their wellness projects.

Customer orientation: We engage with the needs of our customers and satisfy them completely with simple and flexible solutions.

Innovation: Our innovative and reliable products set trends on the market and thereby give our customers a competitive advantage.

International: It is our aim to supply the international market with our products optimally.

Partnership: We always look for mutual solutions with our customers – and also our suppliers. Working as partners creates trust and allows us to fully exploit our shared potential.

World of well-being **sentiotec**

sentiotec provides innovative solutions that function at the touch of a button. Easy to operate and flexible to use – this is something you can count on from our products.

This catalogue includes the real heart of any SPA area: The latest generation in sauna control systems, infrared radiators and steam generators. Sauna heaters from sentiotec are functional and impress with their simple design.

To ensure you are able to offer the full range for your wellness projects, our programme also includes quality accessories: high-quality sauna doors, sensual fragrances, ergonomic head-rests and much more.

Our Sound & Light modules will make wellness a holistic experience. Gentle sounds and soothing colours inspire all your senses. Sit back and relax, welcome to the **sentiotec wellness world**.

TIME OUT

REST

RELAXATION

ENJOYMENT

PEACE



SAUNA

Heaters

14 - 41

Control units

44 - 59

Accessories

62 - 71



INFRARED

Control units

74 - 79

Heaters & accessories

82 - 85



STEAM

Generators & accessories

88 - 91



SOUND & LIGHT

Music & coloured light

94 - 101

Sauna heaters, fin



Concept R Page 16
kW 9 | 10.5 | 12 | 15



Concept R mini Page 18
kW 3.5 | 4.5 | 6 | 7.5



Qube 90 / 150 Page 20
kW 9 | 10.5 | 12 | 15



Qube 240 / 360 Page 21
kW 18-24 | 30-36



Home fin Page 24
kW 4.5 | 6 | 7.5 | 9



Home Premium fin Page 25
kW 7 | 9 | 11



100 Page 27
kW 3.6 | 4.5 | 6 | 9
Internal control



100 E Page 27
kW 3.6 | 4.5 | 6 | 9



200 E Page 27
kW 6 | 9



Viking Page 28
kW 4.5 | 6 | 8 | 9
Internal control



Viking E Page 28
kW 4.5 | 6 | 8 | 9



Rear wall heater Page 29
kW 9 | 10.5



IKI Monolith Page 29
kW 9



Tower heater Page 30
kW 9 | 10.5 | 12



Wall tower heater Page 30
kW 9



Corner tower heater Page 31
kW 9



Ari Page 32
kW 7.5 | 9



Ari Corner Page 32
kW 9



Savonia Page 34
kW 9 | 10.5 | 12 | 15 | 18



Cumulus Page 34
kW 6 | 9
Control internal | external



Scandia NEXT Page 35
kW 4.5 | 6 | 8 | 9
Control internal | external



Mini Page 36
kW 2.3 | 3 | 3.6
Control internal | external



Mini Corner Page 36
kW 3.6



Nordex NEXT Page 37
kW 4.5 | 6 | 8 | 9
Control internal | external



S2 Page 38
kW 16.5

Sauna heaters, wood

Sauna heaters, combi



Concept R combi Page 17
kW 9 | 10.5



Concept R mini combi Page 19
kW 3.5 | 4.5 | 6 | 7.5



Additional evaporator R Page 22
kW 2.5



Home combi Page 24
kW 6 | 9



Home Premium combi Page 25
kW 7 | 9 | 11



Viking combi Page 28
kW 6 | 9



Scandia NEXT combi Page 35
kW 6 | 8 | 9



Mini combi Page 36
kW 3.6



Nordex NEXT combi Page 37
kW 6 | 8 | 9

Sauna control units



home.com4 Page 44



PRO B2 Page 46



PRO B3 Page 46



PRO C2 Page 47



PRO C3 Page 47



PRO D2 Page 50



PRO D2i Page 50



PRO D3 Page 51



PRO D3i Page 51



wave.com4 11 kW Page 56



K1-NEXT Page 57



K2-NEXT Page 57



K3-NEXT Page 57



K4-NEXT Page 58

Infrared controls



Infrabox basic S Page 74



Infrabox Page 74



PRO D Infra Page 75

Sound&Light



PRO D Bluetooth Page 94



PRO D DMX Page 96

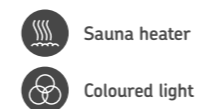

Sauna heater

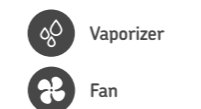

Vaporizer

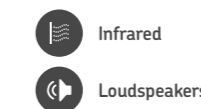

Infrared

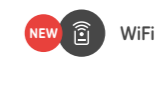

WiFi



Coloured light



Fan



Loudspeakers

Heat has a noticeable effect on the body: ¹

- lowering blood pressure
- maintaining the flexibility of the blood vessels
- improving the function of the arteries
- reducing blood fats
- reducing inflammation



A VISIT TO THE SAUNA INCREASES THE HEART RATE AND IS COMPARABLE TO PLAYING SPORT. ¹

People who go to the sauna 4 to 7 times per week reduce: ¹

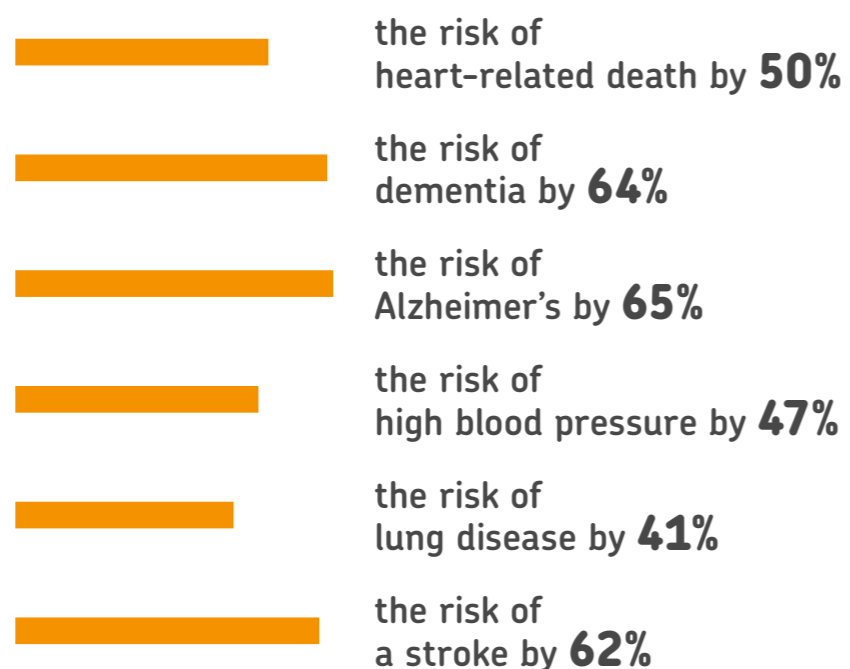

“Regular sauna use has been associated with a lower risk of heart disease, sudden cardiac death, high blood pressure and memory loss.”

JARI LAUKKANEN AND TANJANINNA LAUKKANEN:
“SAUNA, BODY AND MIND” (12/2020)

¹ Professor Hans Hägglund, Uppsala University, Lecturer, 16 December 2020.



Should doctors also prescribe saunas – alongside medication, therapies and physical activity – for the prevention and treatment of diseases?

PROFESSOR HANS HÄGGLUND

APPROX. **500** STUDIES HAVE BEEN PUBLISHED ON THE HEALTH EFFECTS OF SAUNAS. ¹



Saunas are good for the brain as well: ²

- warming up the body
- promoting blood circulation
- reducing inflammation
- releasing endorphins
- improving sleep
- providing social interaction

83% OF THE STUDY PARTICIPANTS SLEPT BETTER AFTER ONE SAUNA SESSION.

HUSSAIN, GREAVES & COHEN 2019



Heat releases endorphins, oxytocin and serotonin, improving mood and increasing well-being. ¹

“A visit to the sauna reduces anxiety and improves concentration.”

Kuusinen & Heinonen 1972

² Based on several studies (Laukkanen, Zaccardi and Knutsor).

Healing with heat



Heat can help us to feel healthier. Whether you choose a sauna, an infrared cabin or a steam bath. The soothing heat can boost your immune system, lift your spirits, relax your muscles, improve your skin's appearance and much more.

When you take a sauna, you are engaging in a primal and natural body experience: a shared experience of nature. This is in marked and obvious contrast to the digitalised world in which we live. The offline environment of a sauna is the perfect antidote to stress and information overload. It's essentially relaxation at a physical and mental level.

IMPORTANT:

For all heat treatments, the maximum session time is 15 minutes. As the body temperature rises sharply, you may experience circulatory problems. Treat your body to some rest and relaxation after a sauna session.

SAUNA

In the sauna, the temperature is high (up to 100 °C) and the humidity is low. The body is heated from the outside and you start to sweat. An infusion can also increase the heat for a short time to make you sweat even more.

There are different types of sauna:

- Smoke sauna (original form)
- Traditional Finnish sauna
- Electrically heated sauna
- Wood-fired sauna
- Bio sauna
- Hybrid sauna



STEAM BATH

Steam baths are also hot and cause you to sweat. One difference between steam baths and saunas is the temperature. In a steam bath, the temperature is lower (45–55 °C) but the humidity is higher, at almost 100%. A steam bath can have especially positive health benefits for rheumatic complaints and cold symptoms.

There are also different types of steam bath:

- Traditional steam bath
- Herbal / aromatherapy
- Salt mist applications
- Hammam

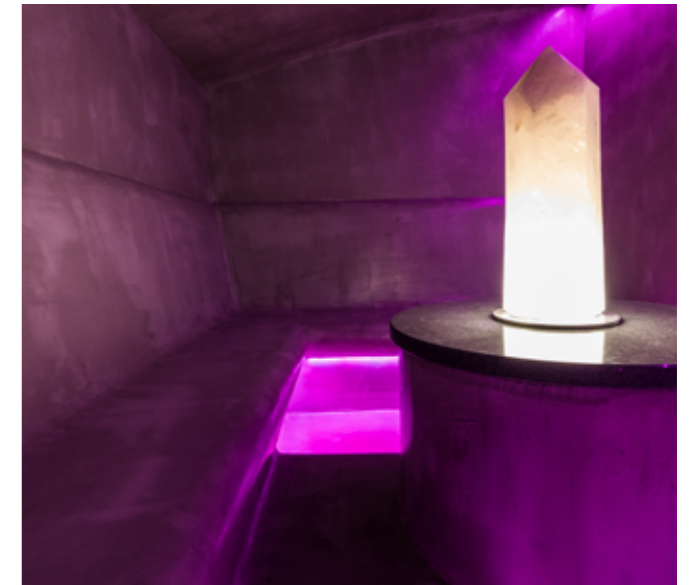

INFRARED

With an infrared full spectrum radiator, you can bring the sun into your home. The temperature in an infrared cabin is 30 – 45 °C (according to ÖNORM M6219-4). The body does not have to expend extra energy to warm up or cool down.

Due to the deep heat effect, the whole body heats up from the inside out. The blood is warmed via the skin and is then distributed throughout the body. The blood vessels dilate, promoting blood circulation and allowing muscle tension to be released.





SAUNA HEATERS

<i>Concept R</i>	16
<i>Concept R combi</i>	17
<i>Concept R mini</i>	18
<i>Concept R mini combi</i>	19
<i>Qube 90 / 150</i>	20
<i>Qube 240 / 360</i>	21
<i>Auxiliary evaporator R</i>	22
<i>Concept R & Qube accessories</i>	23
<i>Home Premium fin</i>	24
<i>Home Premium combi</i>	24
<i>Home fin</i>	25
<i>Home combi</i>	25
<i>100</i>	27
<i>100 E</i>	27
<i>200 E</i>	27
<i>Viking</i>	28
<i>Viking E</i>	28
<i>Viking combi</i>	28
<i>Rear-wall heater</i>	29
<i>IKI Monolith</i>	29
<i>Tower Heater</i>	30
<i>Wall Tower Heater</i>	30
<i>Corner Tower Heater</i>	31
<i>Ari</i>	32
<i>Ari Wall</i>	32
<i>Ari Corner</i>	32
<i>Ari Cubos</i>	33
<i>Savonia</i>	34
<i>Cumulus</i>	34
<i>Scandia NEXT</i>	35
<i>Scandia NEXT combi</i>	35
<i>Mini</i>	36
<i>Mini combi</i>	36
<i>Mini Corner</i>	36
<i>Nordex NEXT</i>	37
<i>Nordex NEXT combi</i>	37
<i>S2 wood burning heater</i>	38
<i>Optional accessories</i>	38
<i>Cut-off rocker switch</i>	40
<i>Emergency stop switch</i>	40
<i>Air humidifiers</i>	40
<i>Door sensor system</i>	41
<i>Sauna stones</i>	41

Practical sauna heater design

The **sauna heaters** from **sentiotec** represent design and technology at the very highest level. The design's clear, straight lines conceal advanced features that will surpass by far your previous sauna experiences.

The heat sources from sentiotec combine the most advanced sauna heater technology in the world with an internationally prize-winning design. High-quality materials: Steel, wood and stone. Details that reach all the senses. Experience the power of the hot stones, feel the steam on your skin, inhale the invigorating vapours. Body and soul are re-energised. Experience true equilibrium of the senses.



DURABLE

The grilles on the heating elements protect them against excess water.



SAFE

The temperature of the outer shell of the Concept R sauna heater remains low thanks to threefold coating.



EASY MAINTENANCE

The sauna heater is easy to maintain. The stone chamber is separated from the heating elements, which means that the stones do not need to be removed when the heating elements are serviced.



AUTOMATIC SWITCH-OFF (OPTIONAL)

The integrated switch-off function provides the highest possible levels of safety without sacrificing attractive design. The rocker switch available as an accessory switches off the sauna heater if it is covered (e.g. by a towel).

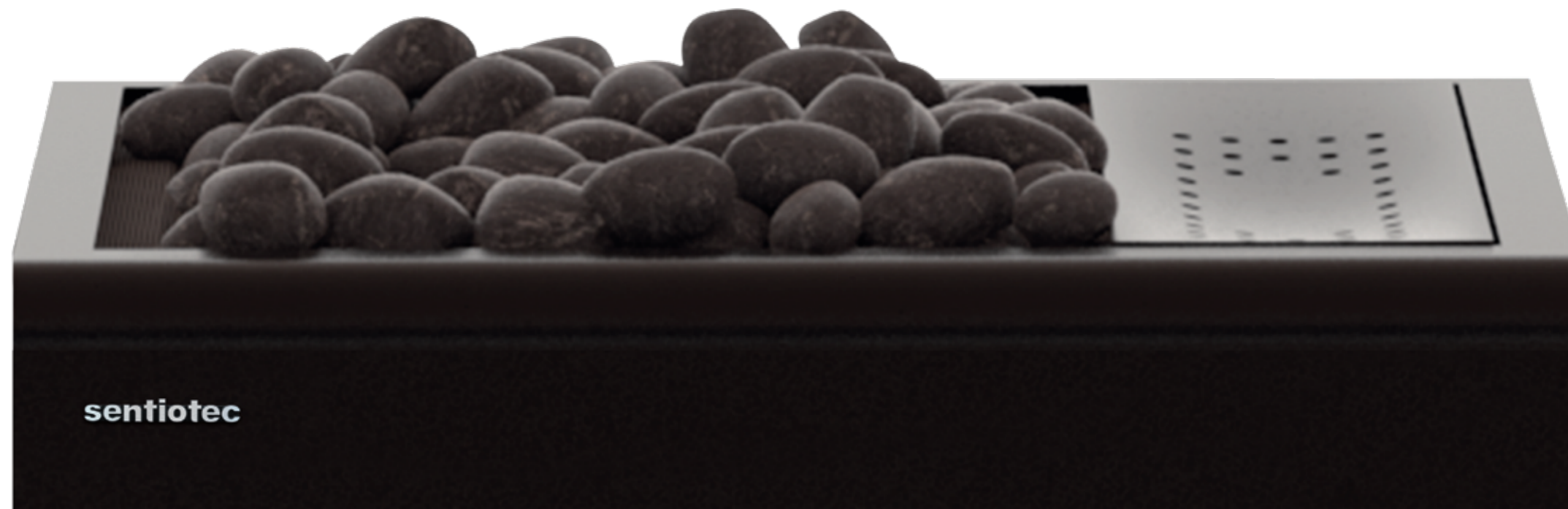
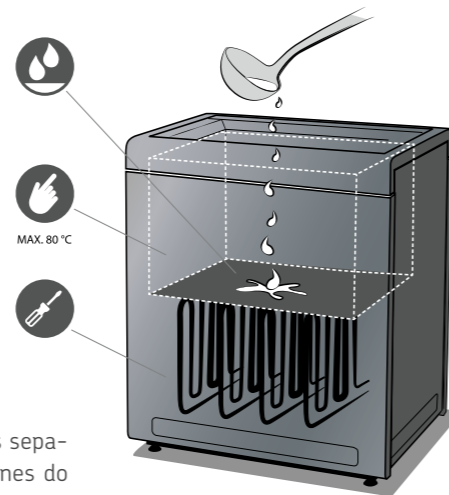

Award-winning design

Our Concept R sauna heaters have won various prizes and awards in international design competitions. The clear, eye-catching design is the starting point for the functionality of the products.

The advanced design of the **Concept R sauna heater** and the market leading technology were awarded the **“Red Dot” prize**. The threefold coating of the sauna heater, the integrated safety switch and the attractive shape that allows the sauna heater to be integrated in any position in the sauna were singled out for special attention.

The advanced shape of the **Concept R mini combi** received the **“iF Design Award” 2018**. The specialist jury particularly praised the design and technology. The stylish base of the Concept R mini combi, which conceals the technology, wiring and connections, received special recognition.



reddot winner



Concept R



Practical sauna heater design.

The Concept R is a designer sauna heater for the modern, private sauna. Sauna technology of the highest level was used when planning the design of the coating. The temperature of the outer shell stays low due to the elaborate, threefold coating.

The Concept R embodies design and technology at the highest level. The smooth, straight-lined shape can be planned into any modern sauna cabin. The thoroughly stylish, black-painted Concept R can be integrated between benches without detracting from its appearance.

To round off the Concept R sauna heater, it has been fitted with a railing that runs seamlessly around the sauna heater. This advanced technology allows the heater to warm up quickly and ensures a long service life of the product. The stones and the heating elements are housed in separate chambers.

An integrated safety switch is offered as an accessory for the Concept R sauna heater. This ensures optimum safety for the sauna without needing to sacrifice the attractive design.

It also enables a remote control to be connected to the sauna heater.

Innovative technology:

- Sauna heater capacity: 9 kW, 10.5 kW, 12 kW and 15 kW
- Exterior parts made of powder coated stainless steel
- Interior parts made of stainless steel
- Easy to service due to detachable connection box
- 3-coating technology
- Adjustable feet
- Optional:
 - "Emotion" wooden railing (linden or walnut) pre-fitted



kW	Item no.
9	CP-RB-090
10.5	CP-RB-105
12	CP-RB-120
15	CP-RB-150



Datasheet

Concept R combi

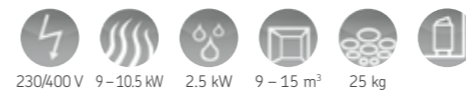

For fans of gentle infusions.

The Concept R combi evaporator heater combines advanced sauna technology and design. The combi sauna heaters are equipped with an evaporator offering an effortless, even more gentle sauna experience. The sauna heater features a separate ceramic fragrance and herb bowl.

The Concept R represents style at the very highest level. The smooth, straight-lined shape of the Concept R was used for the combination model and can be easily planned into a modern sauna cabin. The railing made of light or dark wood lends the robust sauna heater a softer edge.

The stones and the heating elements are housed in separate chambers. This advanced technology allows the heater to warm up quickly and ensures a long service life of the product.

An integrated safety shutdown device is available as an accessory for the Concept R sauna heater. This also allows the heater to be started remotely.



Datasheet

kW	Item no.
9	CP-RCB-090
10.5	CP-RCB-105



Innovative technology:

- Sauna heater capacity: 9 kW and 10.5 kW
- Exterior parts made of powder-coated stainless steel
- Evaporator output: 2.5 kW
- Interior parts made of stainless steel
- Dishwasher-proof cover basins
- Easy to service thanks to removable connection boxes
- 3-coating technology
- Adjustable feet
- Optional:
 - Fixed water connection
 - "Emotion" wooden railing (linden or walnut) pre-fitted

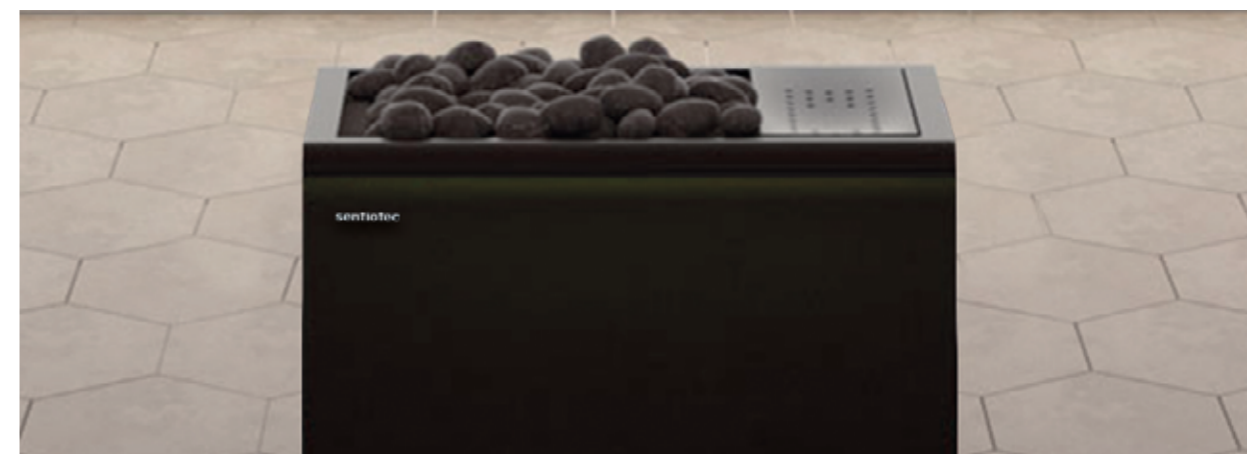

Concept R mini



Compact sauna heater

The latest sauna technology was used in the design of the Concept R mini series. Safety features such as the designer heater railing make the sauna heaters very popular for small saunas. The railing is made of wood and gives the black steel of the sauna heater a softer touch.

The Concept R mini was designed with lasting infusion experiences in mind. The stainless steel interior parts ensure that the heart of the sauna cabin has a long service life. One particular focus of the design phase was easy maintenance with the result that installation and servicing are both easy to perform. The heater can be installed on the wall, or be installed using an optional foot to save space.

Innovative technology:

- Sauna heater capacity: 3.5 kW, 4.5 kW, 6 kW and 7.5 kW
- Exterior parts made of brushed and powder-coated stainless steel
- Interior parts made of stainless steel
- Space-saving installation
- Easy to service due to easily removable terminal box cover
- Quick and easy wall mounting
- Optional:
 - Bracket set for heater railing
 - Wooden railing (linden or walnut)
 - Black, powder-coated stainless steel base
 - Foot cover (linden or walnut)



kW	Item no.
3.5	CP-RM-35
4.5	CP-RM-45
6	CP-RM-60
7.5	CP-RM-75



Datasheet

Concept R mini combi

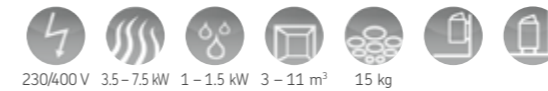

The source of gentle infusions in small saunas

The Concept R mini combi is suitable for fans of gentle infusions. An evaporator is integrated in the inside of the combination heater. This creates gentle infusions that give off long-lasting warmth. The combi heater is the perfect choice for fans of scented infusions.

The Concept R mini combi is equipped with a separate ceramic fragrance and herb bowl. The sauna fragrances further improve the mood.

The Concept R mini combi was designed with lasting and effortless infusion experiences in mind. The stainless steel internal parts ensure the durability of the heart of the sauna cabin. One particular focus of the design phase was easy maintenance with the result that installation and servicing are both easy to perform. The heater can be installed on the wall, or be installed using an optional foot to save space.

Innovative technology:

- Sauna heater capacity: 4.5 kW, 6 kW and 7.5 kW
- Evaporator output: 1 kW (at 7.5 kW – 1.5 kW)
- Interior parts made of stainless steel
- Space-saving installation
- Easy to service due to easily removable terminal box cover
- Quick and easy wall mounting
- Optional:
 - Bracket set for railing
 - Wooden railing (linden or walnut)
 - Black, powder-coated stainless steel base
 - Foot cover (linden or walnut)



kW	Item no.
4.5	CP-RMC-45
6	CP-RMC-60
7.5	CP-RMC-75



Datasheet



Qube 90 / 150



For those with exclusive taste in sauna equipment

The Qube fulfils the wishes of those with the most exclusive tastes in sauna equipment. The clear lines and the modern black in combination with the stainless steel collar of the heater really draw the eye.

The carefully selected materials and the innovative collar construction make the Qube the perfect choice for public baths, hotels or large family saunas.

sentiotec creates a relaxing sauna experience and infusions that appeal to all the senses. The stone chamber of the stylish Qube heater consists of a graphite black bottom part and is framed by brushed steel.

The outer shape of the Qube means that it can be placed anywhere in the sauna furnishings as all sides of the Qube can face the user.

The optional, wooden safety railing gives the otherwise robust appearance of the Qube an air of lightness and also ensures safety in the sauna.

The stylish exterior of the Qube has a threefold coating, thanks to which the temperature of the exterior of the sauna heater remains low as the heater warms the sauna.

The Qube sauna heaters are easy to maintain as the stone chamber and heating elements are separated from each other. The separate stone chamber allows the heating elements to be maintained without the stones having to be removed. The construction also protects the heating elements against excess water and the weight of the stones, thereby prolonging the service life of the heating elements. The detachable connection box makes it possible to conduct assembly and maintenance work quickly and simply.

Innovative technology:

- Sauna heater capacity: 9 kW, 10.5 kW, 12 kW and 15 kW
- Exterior parts made of brushed and powder-coated stainless steel
- Interior parts made of stainless steel
- Easy to service due to detachable connection box
- 3-coating technology
- Adjustable feet
- Optional:
 - Bracket set for railing
 - Wooden ring (linden or walnut)



kW	Item no.
9	QUBE-090
10.5	QUBE-105
12	QUBE-120
15	QUBE-150



Datasheet

Qube 240 / 360



For professional infusion experiences

The Qube is a sauna heater designed for commercial and continuous operation and provides gentle infusions. It stands out thanks to its stylish design and long service life. The carefully selected materials and the innovative collar construction make the Qube the reliable choice for public baths and hotels.

The stone chamber of the stylish Qube heater consists of a graphite black coat and is framed by brushed steel. As all sides of the Qube can face the user, it can be placed anywhere in the sauna. We recommend rounding off the sauna heater with the wooden railing.

This gives the otherwise robust appearance of the Qube an air of lightness and also ensures safety in the sauna.

The stylish exterior has a threefold coating, thanks to which the temperature of the exterior of the sauna heater remains low as the heater warms the sauna.

Innovative technology:

- Sauna heater capacity: 18 kW / 21 kW / 24 kW and 30 kW / 33 kW / 36 kW
- Exterior parts in brushed and powder-coated stainless steel
- Interior parts made of stainless steel
- Easy to service due to detachable connection box
- 3-coating technology
- Adjustable feet
- Optional:
 - Bracket set for railing
 - Wooden railing (linden or walnut)
 - Cable cover (SAA00102)



kW	Item no.
18-24	QUBE-240
30-36	QUBE-360



reddot winner 2020



Datasheet
Qube-240



Datasheet
Qube-360



Auxiliary evaporator R



The perfect complement to Concept R

The additional evaporator R creates steam in your sauna as a standalone device or as an expansion module for the Concept R heater series.

Retrofitting the additional evaporator R in existing sauna cabins with infusion heaters is simple.

The additional evaporator R stands out due to its intelligent product design with high-quality materials such as porcelain and stainless steel. The evaporator, which has an output of 2.5 kW works underneath the porcelain storage compartment for fragrant oils and herbs and thereby creates an optimum wellness climate in the sauna cabin.



kW	Item no.
2.5	CP-25-STP-B



Datasheet

Innovative technology:

- Evaporator output: 2.5 kW
- Can be combined with Finnish sauna heaters
- Can be mounted on the wall and on the Concept R sauna heater (page 14)
- Exterior parts made of brushed and powder-coated stainless steel
- Dishwasher-proof, ceramic cover basins
- Optional:
 - Bracket set for railing
 - Wooden railing (linden or walnut)
 - Auto-refill



Concept R & Qube accessories

Concept R mini combi 3.5–7.5 kW

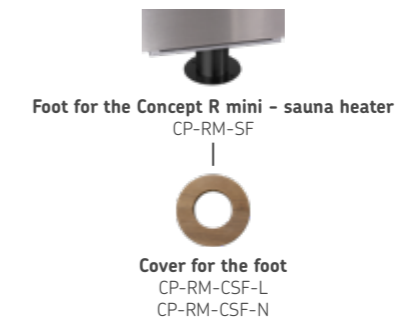
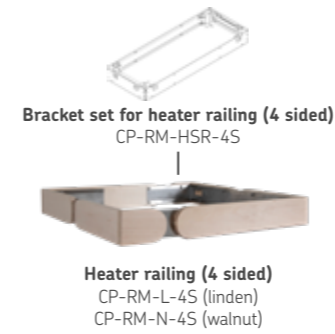

Concept R mini combi 3.5–7.5 kW

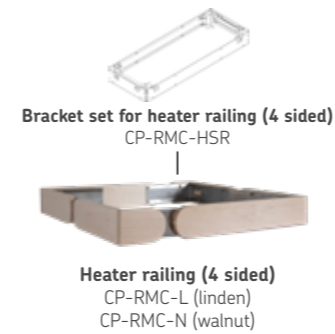

Concept R 9–10.5 kW

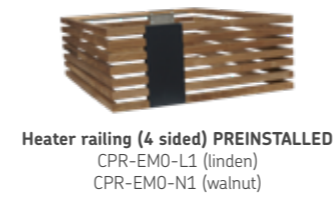

Concept R 12–15 kW, Concept R combi 9–10.5 kW

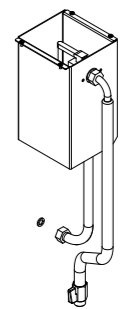

Auto-refill
Item no. CP-RC-AF

Qube 9–10.5 kW

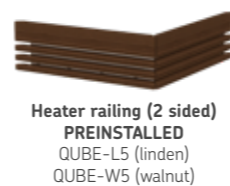

Qube 12–15 kW

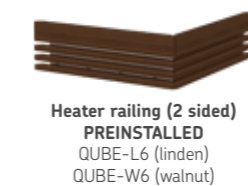

Qube 24 kW

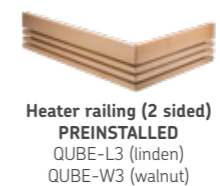

Qube 36 kW



Home Premium fin



230/400 V 7–11 kW 5–18 m³ 50–70 kg

The Home Premium fin is a powerful, practical, simply constructed and stylish sauna heater for those who want a traditional sauna experience. The Home Premium fin is the perfect choice for medium to large saunas.

Innovative technology:

- Sauna heater capacity: 7 kW, 9 kW and 11 kW
- External control unit
- Heating rods and stone chamber separate from each other
- Stone chamber made of robust stainless steel
- Quick and easy assembly
- Optional:
 - Wooden railing (linden or walnut) pre-assembled
 - Water drip tray (SAA00101)



kW	Item no.
7	STL704
9	STL904
11	STL1104



Datasheet

Home Premium combi



400 V 7–11 kW 2 kW 5–18 m³ 50–70 kg

The Home Premium combi is a stylish and versatile combination of sauna heater and evaporator. The combi heater is the right choice for those who appreciate gentle steam and the atmosphere that special fragrances create in the sauna.

Innovative technology:

- Sauna heater capacity: 7 kW, 9 kW and 11 kW
- External control unit
- Heating rods and stone chamber separate from each other
- Stone chamber made of robust stainless steel
- Quick and easy assembly
- Optional:
 - Wooden railing (linden or walnut) pre-assembled
 - Water drip tray (SAA00101)



kW	Item no.
7	STL704S
9	STL904S
11	STL1104S



Datasheet

Home fin



230/400 V 4.5–9 kW 3–14 m³ 20–30 kg

With the Home fin sauna heater, sentiotec maintains its high standards of design and function. The straight lines and the dark colours characterise the design of the Home fin sauna heater.

Innovative technology:

- Sauna heater capacity: 4.5 kW, 6 kW, 7.5 kW and 9 kW
- Powder coated exterior parts
- Interior parts made of stainless steel
- Adjustable stone tray volume
- External control unit
- Rust and scale-free heating rods
- Integrated water drip tray
- Suitable for monophasic connection
- Quick and easy assembly
- Optional:
 - Wooden railing (linden or walnut) pre-assembled



kW	Item no.
4.5	HOME-F45
6	HOME-F60
7.5	HOME-F75
9	HOME-F90



Datasheet

Home combi



400 V 6–9 kW 2 kW 5–14 m³ 20–30 kg

With the Home combi sauna heater, sentiotec is maintaining its high standards of design and function. The design of the Home combi sauna heater features straight lines and dark colours.

Innovative technology:

- Sauna heater capacity: 6 kW and 9 kW
- Evaporator output: 2 kW
- Wall mounting
- Powder coated exterior parts
- Interior parts made of stainless steel
- Adjustable stone tray volume
- External control unit
- Rust and scale-free heating rods
- Integrated water drip tray
- Suitable for monophasic connection
- STB easy to reset
- Water easy to drain through the easy-to-access water tap
- Quick and easy assembly
- Optional:
 - Wooden railing (linden or walnut) pre-assembled



kW	Item no.
6	HOME-C60
9	HOME-C90



Detailed view of evaporator



Datasheet



Home accessories

Home fin & Home combi



Heater railing (3 sided)
pre-assembled, bracket set included
HOME-F-L1 (linden)
HOME-F-N1 (walnut)



Heater railing (3 sided)
pre-assembled, bracket set included
HOME-C-L1 (linden)
HOME-C-N1 (walnut)



Optionally also available without wooden railing:
Bracket set for heater railing (3 sided)
HOME-HSR

Home Premium fin 7 & 9 kW



Heater railing (4 sided)
pre-assembled, bracket set included
STL-L1 (linden)
STL-N1 (walnut)



Optionally also available without wooden railing:
Bracket set for heater railing (4 sided)
STL-HSR

Home Premium fin 11 kW & Home Premium combi 7-9 kW



Heater railing (4 sided)
pre-assembled, bracket set included
STL-L2 (linden)
STL-N2 (walnut)

Home Premium combi 11 kW



Heater railing (4 sided)
pre-assembled, bracket set included
STL-L3 (linden)
STL-N3 (walnut)

Water drip tray

suitable for all ovens in the Home series

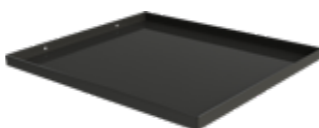

Water drip tray
(SAA00101)

100



230/400 V 3.6-9 kW 2-14 m³ 11-20 kg



Datasheet



*sentiotec sauna heaters with integrated control unit
The 100 represents outstanding value for money.
A compact heater with a clear design.*

Innovative technology:

- Sauna heater capacity: 3.6 kW, 4.5 kW, 6 kW and 9 kW
- Integrated control unit
- Quick and easy assembly
- Suitable for monophase connection
- Free choice of the side on which the knob is installed
- Corner mounting easily possible (3.6 kW)

kW	Item no.
3.6	ST136400B
4.5	ST145400B
6	ST160400B
9	ST190400B

100 E



230/400 V 3.6-9 kW 3-14 m³ 20 kg



Datasheet



*The 100 E represents outstanding value for money.
A compact heater with a clear design.*

Innovative technology:

- Sauna heater capacity: 3.6 kW, 4.5 kW, 6 kW and 9 kW
- External control unit
- Quick and easy assembly
- Suitable for monophase connection
- Corner mounting easily possible (3.6 kW)

kW	Item no.
3.6	ST136400BE
4.5	ST145400BE
6	ST160400BE
9	ST190400BE

200 E



230/400 V 6-9 kW 3-14 m³ 20 kg



Datasheet



*The 200 E makes an impression with its high-quality design.
A solid heater with a heater cover made of elegant cast aluminium.*

Innovative technology:

- Sauna heater capacity: 6 kW and 9 kW
- External control unit
- Quick and easy assembly
- Suitable for monophase connection

kW	Item no.
6	ST260400BE
9	ST290400BE



Viking



Datasheet



sentiotec sauna heaters with integrated control unit
The Viking impresses with its slim and simple design.
The convenient height of the knobs makes it very user-friendly. The stainless steel outer case makes it very easy to care for, and very durable.

Innovative technology:

- Sauna heater capacity: 4.5 kW, 6 kW, 8 kW and 9 kW
- Integrated control unit
- Quick and easy assembly
- Suitable for monophase connection
- Free choice of the side on which the knob is installed

kW	Item no.
4.5	ST345400
6	ST360400
8	ST380400
9	ST390400

Viking E



Datasheet



The Viking E impresses with its slim and simple design.
The convenient height of the knobs makes it very user-friendly.
The stainless steel outer case makes it very easy to care for, and very durable.

Innovative technology:

- Sauna heater capacity: 4.5 kW, 6 kW, 8 kW and 9 kW
- External control unit
- Quick and easy assembly
- Suitable for monophase connection

kW	Item no.
4.5	ST345400E
6	ST360400E
8	ST380400E
9	ST390400E

Viking combi



Datasheet



The Viking combi creates a perfect steam sauna experience with its additional evaporator.

Innovative technology:

- Sauna heater capacity: 6 kW and 9 kW
- Evaporator output: 2 kW
- External control unit
- Quick and easy assembly

kW	Item no.
6	ST360400S
9	ST390400S

Rear-wall heater



The rear-wall heater – its intelligent design guarantees a one-of-a-kind sauna experience.

Innovative technology:

- Sauna heater capacity: 9.0 kW and 10.5 kW
- External control unit
- Stainless steel inner and outer casing
- Rust and scale-free heating rods
- Service friendly
- Patented rear-wall maintenance system
- 100 % stainless steel, integrated drip tray, removable stone basket, detachable connection box
- Detachable infusion channel
- Hose (1.5 m) and infusion bowl included in delivery

kW	Item no.
9	HWO-090NS-P
10.5	HWO-105NS-P



Datasheet

IKI Monolith



Nordic design meets traditional Finnish craftsmanship, making it simply different from everything else.
The IKI Monolith not only stands out with its design and craftsmanship from Finland but also guarantees you a special sauna and infusion experience.

Innovative technology:

- Sauna heater output: 9.0 kW
- Exterior parts in brushed stainless steel
- Interior parts made of stainless steel
- After infusion, steam is released in all directions, providing long-lasting and even heat distribution
- By controlled addition of water in the lower or upper area of the heater, the steam burst can be mild or strong
- Easy loading with stones by opening of one of the side parts
- Optional:
 - Stainless steel edging

kW	Item no.
9	MLT-090NS



Datasheet

The large volume of stones allows for perfect infusion, but whilst also extending the warm-up time.



Tower Heater

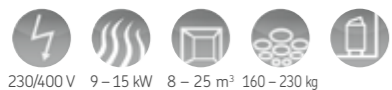

230/400 V 9–15 kW 8–25 m³ 160–230 kg

SAWOTEC sauna heaters
The trendsetter for your sauna!

Innovative technology:

- Sauna heater capacity: 9 kW, 10.5 kW and 12 kW
- Only available with an external control unit
- Even distribution of heat in all directions
- Mild or strong steam burst by controlled addition of water
- Screw-on feet for perfect alignment
- Easy loading with stones by opening the centre stone basket
- Air duct installed on the inside

Stones must be ordered separately.

The large volume of stones allows for perfect infusion, but whilst also extending the warm-up time.



kW	Item no.
9	TH6-090NS
10.5	TH6-105NS
12	TH6-120NS



Datasheet

Wall Tower Heater



230/400 V 6–9 kW 5–14 m³ 80–110 kg

SAWOTEC wall model
The sauna heater is also available as a space-saving wall model.

Innovative technology:

- Sauna heater capacity: 9 kW
- Only available with an external control unit
- Space-saving through wall mounting
- Even heat distribution
- By controlled addition of water in the lower or upper area of the heater, the steam burst can be mild or strong
- Screw-on feet for perfect alignment
- Easy loading with stones by opening of the centre stone basket
- Air duct installed on the inside

Stones must be ordered separately.

The large volume of stones allows for perfect infusion, but whilst also extending the warm-up time.



kW	Item no.
9	TH5-90NS-WL



Datasheet

Corner Tower Heater



230/400 V 6–12 kW 5–18 m³ 70–160 kg

The tower heater is also available as a space-saving corner model.

Innovative technology:

- Sauna heater capacity: 9 kW
- Only available with an external control unit
- Even distribution of heat in all directions
- By controlled addition of water in the lower or upper area of the heater, a mild or strong burst of steam can be produced
- Screw-on feet for perfect alignment
- Easy loading with stones by opening of the centre stone basket
- Air duct installed on the inside

Stones must be ordered separately.

The large volume of stones allows for perfect infusion, but whilst also extending the warm-up time.



kW	Item no.
9	TH5-90NS-CNR



Datasheet

Tower Heater accessories:

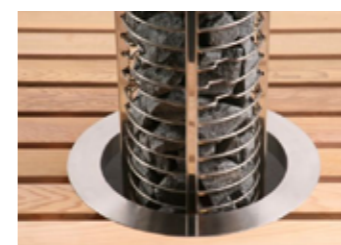

Stainless steel:

Item no.
TH-COLLAR-ST6

TOWER HEATER



Railing:

Item no.
TH-GUARD-W6

Stainless steel:

Item no.
TH-COLLAR-ST4-WL

TOWER WALL

Stainless steel:

Item no.
TH-COLLAR-ST4-CNR

TOWER CORNER

Railing:

Item no.
TH-GUARD-W4-WL

Railing:

Item no.
TH-GUARD-W4-CNR



Ari



SAWOTEC sauna heater – the tower heater is also available as a space-saving wall and corner model.

Innovative technology:

- Sauna heater capacity: 7.5 kW and 9 kW
- Available with an external or integrated control unit
- Stainless steel casing
- Even distribution of heat in all directions
- The controlled addition of water in the lower or upper area of the heater enables a mild or strong burst of steam to be produced
- Screw-on feet for perfect alignment



Without control unit:

kW	Item no.
7.5	ARI3-75NS
9	ARI3-90NS



Datasheet

Ari Corner



corner model

Innovative technology:

- Sauna heater capacity: 7.5 kW and 9 kW
- Available with an external or integrated control unit
- Stainless steel casing
- Even distribution of heat in all directions
- The controlled addition of water in the lower or upper area of the heater enables a mild or strong burst of steam to be produced
- Screw-on feet for perfect alignment

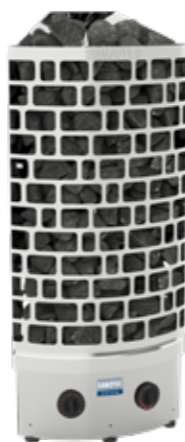

With control unit:

kW	Item no.
9	ARI3-90NB-CNR



Datasheet

Ari sauna heater accessories:



ARI HEATER

Stainless steel:

Item no.

TH-COLLAR-ST4

Railing:

Item no.

TH-GUARD-W3-D

TH-GUARD-W3-A

ARI CORNER

Stainless steel:

Item no.

TH-COLLAR-ST4-CNR

Railing:

Item no.

TH-GUARD-W4-CNR



Savonia

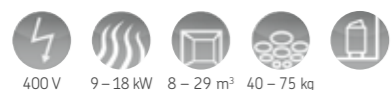

SAWOTEC stainless steel
The Savonia ensures ideal warming of the entire stone quantity and larger infusions.

Innovative technology:

- Sauna heater capacity: 9 kW, 10.5 kW, 12 kW, 15 kW and 18 kW
- External control unit
- Stainless steel inner and outer casing
- Heating rods run through the entire stone basket
- Stainless steel stone grate
- Rust and scale-free heating rods
- Screw-on feet for perfect alignment



kW	Item no.
9	SAV-090N-P
10.5	SAV-105N-P
12	SAV-120N-P
15	SAV-150N-P
18	SAV-180N-P



Datasheet

Cumulus



Soapstone and stainless steel form a harmonious unity in the Cumulus.

Innovative technology:

- Sauna heater capacity: 6 kW and 9 kW
- Stainless steel inner and outer casing
- The front side of the soapstone elements is encased in stainless steel
- Includes embedded soapstone bowls for fragrant essences
- Available with integrated (NB models) or external control unit
- Rust and scale-free heating rods



Without control unit:		With control unit:	
kW	Item no.	kW	Item no.
6	CML-60NS-P	6	CML-60NB-P
9	CML-90NS-P	9	CML-90NB-P



Datasheet

The large volume of stones allows for perfect infusion, but whilst also extending the warm-up time.

Scandia NEXT

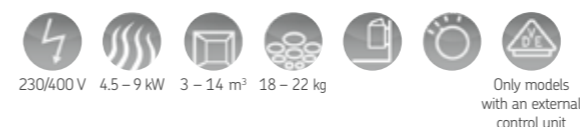

SAWOTEC sauna heater
The Scandia NEXT is suitable for small to medium-sized sauna and stands out thanks to its large container for stones.

Innovative technology:

- Sauna heater capacity: 4.5 kW, 6 kW, 8 kW and 9 kW
- Available with an external or integrated control unit
- Flexible control unit installation (right or left – NB model)
- Cover frame and heat shield made of stainless steel
- Brushed stainless steel outer casing
- Inner casing and rock grate made of aluzinc
- Rust and scale-free heating rods
- Also available as a single-phase heater
- Optional:
 - Drip tray HP02-016

No preset time for models with built-in control unit.



Without control unit:		With control unit:	
kW	Item no.	kW	Item no.
4.5	SCA-45NS-N	4.5	SCA-45NB-N
6	SCA-60NS-N	6	SCA-60NB-N
8	SCA-80NS-N	8	SCA-80NB-N
9	SCA-90NS-N	9	SCA-90NB-N



Datasheet

Scandia NEXT combi

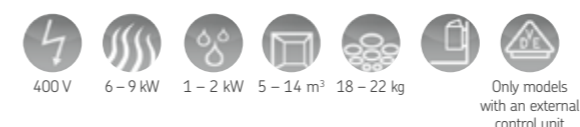

SAWOTEC sauna heater
Steam sauna experience in a more compact and attractive design.

Innovative technology:

- Sauna heater output 6 kW, 8 kW and 9 kW
- Evaporator output: up to 2 kW
- External control unit
- Cover frame and heat shield made of stainless steel
- Brushed stainless steel outer casing
- Inner casing and rock grate made of aluzinc
- Rust and scale-free heating rods
- With integrated low-water indicator
- Quick and easy assembly
- Heating element for the evaporator is under the tank and does not come into contact with water
- Includes soapstone bowls for fragrant essences
- Steam outlet grille for herbs
- Optional:
 - Drip tray HP02-016



kW	Item no.
6	SCAC-60NS-N
8	SCAC-80NS-N
9	SCAC-90NS-N



Datasheet



Mini



Datasheet



SAWOTEC sauna heater
Total Finnish sauna enjoyment despite being small in size – the Mini.

Innovative technology:

- Sauna heater output 2.3 kW, 3 kW and 3.6 kW
- Available with an external or integrated control unit (NB model)
- Flexible control unit installation (right or left)
- Stainless steel stone grate
- Rust and scale-free heating rods
- Optional:
 - Drip tray HP02-026

Without control unit:		With control unit:	
kW	Item no.	kW	Item no.
2.3	MN-23NS-Z	2.3	MN-23NB-Z
3	MN-30NS-Z	3	MN-30NB-Z
3.6	MN-36NS-Z	3.6	MN-36NB-Z

Mini combi



Datasheet



SAWOTEC combi heater
Perfect evaporator heater for the smallest sauna cabins.

Innovative technology:

- Sauna heater capacity: 3.6 kW
- Evaporator output: 1 kW
- External control unit
- Rust and scale-free heating rods
- With water shortage connection
- Heating element for the evaporator is under the tank and does not come into contact with water
- Includes soapstone bowl for fragrant essences
- Optional:
 - Drip tray HP02-026

kW	Item no.
3.6	MNC-36NS-Z

Mini Corner



Datasheet



SAWOTEC corner version – the Mini X is specially designed for installation in the corners of the sauna cabin.

Innovative technology:

- Sauna heater capacity: 3.6 kW
- Available with an integrated control unit
- Rust and scale-free heating rods
- Optional:
 - Drip tray HP02-026

kW	Item no.
3.6	MX-36NB-Z

Nordex NEXT

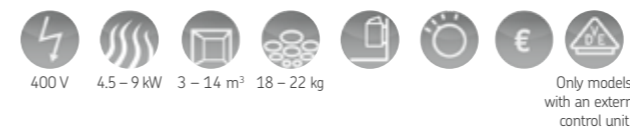

SAWOTEC sauna heater
The Nordex NEXT sauna heater, despite its small size, offers a large container for stones and is easy to install.

Innovative technology:

- Sauna heater output 4.5 kW, 6 kW, 8 kW and 9 kW
- Available with an external or internal control unit
- Stainless steel outer casing, aluminium-zinc inner casing
- Rust and scale-free heating rods
- Quick and easy assembly
- Optional:
 - Drip tray HP02-016

Without control unit:		With control unit:	
kW	Item no.	kW	Item no.
4.5	NR-45NS-N	4.5	NR-45NB-N
6	NR-60NS-N	6	NR-60NB-N
8	NR-80NS-N	8	NR-80NB-N
9	NR-90NS-N	9	NR-90NB-N

Nordex NEXT combi



combi heater
The Nordex NEXT combi allows you to decide whether you prefer a Finnish or a steam sauna.

Innovative technology:

- Sauna heater output 6 kW, 8 kW and 9 kW
- Evaporator output: 2 kW
- Stainless steel outer casing, aluminium-zinc inner casing
- Integrated water shortage system
- Rust and scale-free heating rods
- Quick and easy assembly
- Heating element for the evaporator is under the tank and does not come into contact with water
- Optional:
 - Drip tray HP02-016

kW	Item no.
6	NRC-60NS-N
8	NRC-80NS-N
9	NRC-90NS-N



Drip tray
HP02-016
HP02-026



Datasheet



S2 wood burning sauna heater



The wood burning S2 sauna heater will attract plenty of admiring glances with its classic, elegant design, and is ideally suited for small, wood heated saunas.

Innovative technology:

- Heating output 16.5 kW
- Quick and easy assembly
- Empty weight 46 kg
- BimSchV1



kW	Item no.
16.5	WKM16X-1



Datasheet

Optional accessories:

Optional accessories:

- Chimney set (205-DWETN115)
- Stainless steel chimney (WHP1500)
- Steel chimney (WHP1500M)
- Floor protection plate, black (WL100)
- Protective cover, single side (WL400)
- Protective cover, 3-sided (WL450)
- BIMSCH 1 set (WX540)
- Fireplace set for barrel saunas (WHP1500BSM)



Item no.
WHP1500
WHP1500M

Item no.
WL100



Item no.
WX540

Item no.
WL400

Item no.
WL450

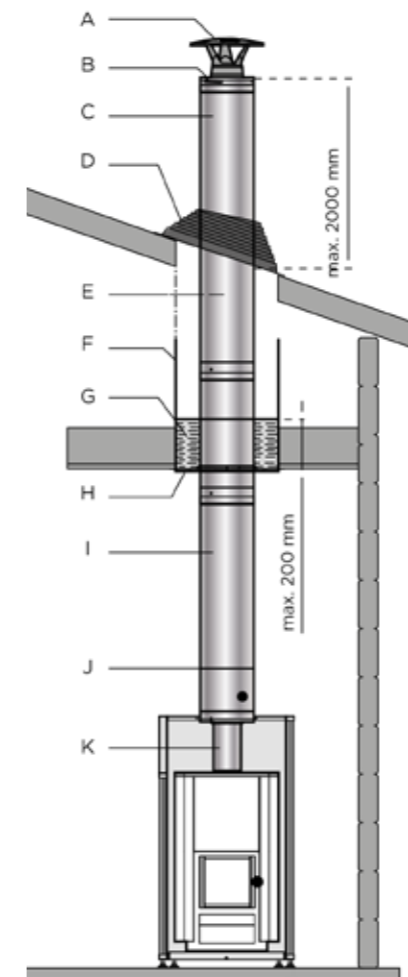

Chimney set WHP1500 / WHP1500M

- A Rain hood
- B Upper end piece
- C Steel chimney extension 0.5–1 m
- D Clamp and rain collar (rubber)
- E Minimum distance 100 mm
- F Protective jacket
- G Feedthrough insulation
- H Feedthrough collar
- I Steel chimney 1.5 m
- J Slider for steel chimney
- K Non-insulated stovepipe 1 m, stainless steel

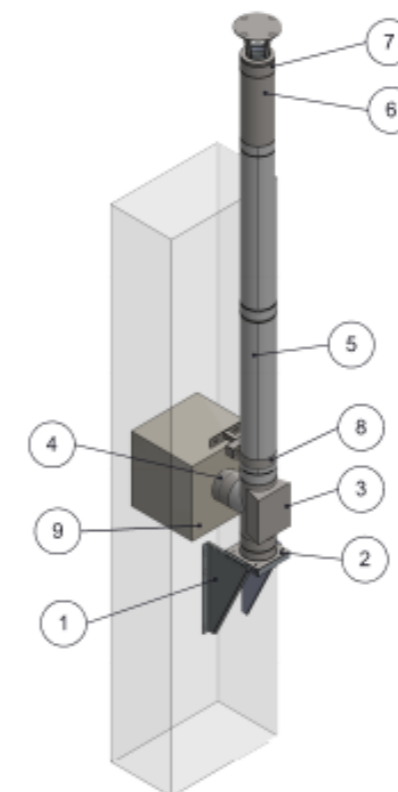

Chimney set DWETN-115

- 1 Bracket plates, adjustable
- 2 Base plate
- 3 T-connection 90°
- 4 LE 500 mm with integrated wall guide, can be shortened
- 5 Length element 1000 mm
- 6 Length element 500 mm
- 7 Rain hood with mouth opening
- 8 Wall spacer
- 9 Wall feedthrough



Cut-off rocker switch

For your safety: a modular shut-off rocker switch for sauna heaters.

Innovative technology:

- Safety shut-off for sauna heaters
- Shut-off when load is placed on the rocker switch (e.g. towel)
- Suitable for installation on the wall above the sauna heater
- Fulfils the requirements for remote operation as per DIN EN 60335-2-53
- In a round and rectangular version and in different dimensions:
 - Rectangular: 220 x 400 mm or 350 x 400 mm or 500 x 500 mm
 - round / diameter: 530 mm or 450 mm or 350 mm

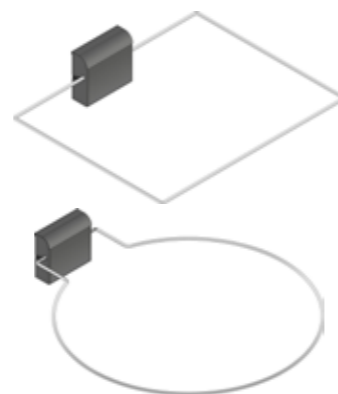

Rectangular:	Round:
Item no.	Item no.
SFE-220400	SFE-D350
SFE-350400	SFE-D450
SFE-500500	SFE-D530



Datasheet

Emergency stop switch

The two-sided installation plate allows two different installation depths, ensuring flexible installation.

- Option 1: 37 mm installation depth
- Option 2: 23 mm installation depth

Innovative technology:

- 2 circuits: 1 NC and 1 NO contact

Scope of delivery:

- Emergency stop switch with installation plate
- Silicon cable, 2-pole 3 m
- 4 x screws 3.2 x 40 mm



Item no.

A-EMS

Install the emergency stop switch at a maximum height of 100 cm and ideally right next to the doors.



Datasheet

Air humidifiers



Sauna air humidifier
Cylindrical
Item no. HP01-070



Sauna air humidifier
Rectangular
Item no. HP01-071

Door sensor system

For all control units with a remote start function: PRO series, wave.com4 11 kW, home.com4

The door sensor allows you to remotely switch on the sauna heater and safely control other functions in the sauna area. The sauna door must be closed for the remote start to be activated via the control panel.

Scope of delivery:

- Door monitoring control unit
- Illuminated button with 2 m connection cable
- Door sensor with 2 m connection cable
- Magnet



Item no.

SAB00102



Datasheet

Door sensor

Innovative technology:

- Small and space-saving
- Easy installation
- High ease of use



Item no.

SAB00102

Sauna stones

For your infusion



Finnish sauna stones
20 kg, 5–10 cm
Item no. R-990



Finnish sauna stones
20 kg, 10–15 cm
Item no. R-993



Round Finnish sauna stones
15 kg, 5–10 cm
Item no. R-991





SAUNA CONTROL UNITS

<i>home.com4</i>	44
<i>PRO B2, PRO B3</i>	46
<i>PRO C2, PRO C3</i>	47
<i>PRO D series overview</i>	48
<i>PRO D2, PRO D2i</i>	50
<i>PRO D3, PRO D3i</i>	51
<i>MySentio</i>	52
<i>MySentio WiFi</i>	53
<i>MySentio remote start set</i>	54
<i>PRO series connectivity overview</i>	55
<i>wave.com4 11 kW</i>	56
<i>K1-NEXT</i>	57
<i>K2-NEXT</i>	57
<i>K3-NEXT</i>	57
<i>K4-NEXT</i>	58
<i>Power booster</i>	58
<i>Sensor</i>	59
<i>Accessories</i>	59

Modern sauna technology

home.com4 is a control unit with Bluetooth technology that enables the control of sauna functions with a mobile device. home.com4 controls all types of saunas: biosaunas, conventional saunas, infrared saunas or combinations of the two – hybrid saunas. You can also control the lighting and music playback in your sauna.

The functions can also be controlled using the stylish operating unit. The selection menu is clear and self-explanatory. home.com4 is the perfect solution for family and public saunas and can be secured with an access code.



home.com4 turns your intelligent device into the sauna control panel:

- User-friendly Bluetooth control with your mobile device.
- The program for mobile devices can be downloaded from the App Store and Google Play. It also contains a demo version.
- All control functions of the sauna in one device
- Control of max. for 10.5 kW sauna heaters
- Connection of an additional power unit (required for electric sauna heaters over 10.5 kW)
- Control of the infrared radiator (3.5 kW or max. 500 W with dimmer)
- Control of the evaporator max. 3.5 kW
- Control of the coloured LED lighting (max. 4 units RGBW coloured light groups to be controlled by DMX)
- Control of a light source of max. 100 W
- Control of the fan (max. 100 W)
- Available in black and white
- Automatic post-drying program
- User profiles



For WiFi use:

NEW

Item no.	Item no.
HC4-B	HC4-B-RS485
HC4-W	HC4-W-RS485

with RS485 interface for bus connection to the house bus system as well as for MySentio in combination with S-WIFI-01



PRO B2, PRO B3



For commercial sauna use

Great demands are placed on control systems for commercial use. sentiotec has risen to this challenge with the versatile PRO series, designed for demanding objectives.

The PRO B control unit is mostly used in saunas in public baths and hotels. The sauna cabin can be easily controlled, in particular if the PRO Net control unit is connected to the Internet.

Only high-quality and durable materials are used in the devices. They provide convenient user-friendliness with a clear selection menu.

The lighting and the ventilation of the sauna can also be controlled with the control unit.

Clear display to control conventional sauna PRO B2:

- Very user-friendly
- Digital temperature display
- Control of the electric heater (max. 10.5 kW)
- Connection of an additional power unit (required for electric heaters over 10.5 kW)
- Control of the lighting and ventilation (max. 100 W), not dimmable
- Can be remotely controlled (PRO Net/standard RS485 interface)
- Connection for safety devices of the electric heater
- Timer function
- Potential-free remote start
- Heating time limit can be extended (6/12/18/24)
- One or two-sensor system

PRO B3 (in addition to PRO B2):

- Digital humidity display
- Automatic post-drying program
- Control of the evaporator (max. 3.5 kW)

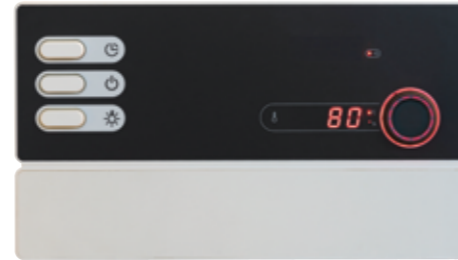

PRO B2

To control the sauna heater and the lighting

Item no.

PRO-B2



Datasheet



PRO B3 Combi

To control the sauna heater, combi heater, lighting and automatic post-drying program

Item no.

PRO-B3



Datasheet



WiFi capable
S-WIFI-01 as well as door sensor or switch-off rocker for WiFi use required

PRO C2, PRO C3



For new sauna experiences

The combination of electric heaters and infrared radiators gives rise to a new type of sauna experience. Sauna heaters and infrared radiators can be easily and conveniently controlled with the aid of the PRO C control unit.

The PRO C control unit has been designed for commercial use and for controlling sauna heaters with a high output. The lighting and the ventilation of the sauna can also be controlled with the control unit.

The PRO Net allows the device to be controlled remotely.

Clear display for controlling the hybrid sauna PRO C2:

- Easy user access
- Storing user profiles
- Digital temperature display
- Control of the electric heater (max. 10.5 kW)
- Connection of an additional power unit (required for electric heaters over 10.5 kW)
- Control of the lighting and ventilation with dimmer
- Control of the infrared radiators (switchable 3.5 kW or max. 500 W, dimmable)
- Can be remotely controlled (PRO Net/standard RS485 interface)
- Connection for the safety device of the electric heater
- Timer function and setting of the operating time
- Potential-free remote start
- One or two-sensor system
- Eco mode

PRO C3 (in addition to PRO C2):

- Digital humidity display
- Automatic post-drying program
- Control of the evaporator (max. 3.5 kW)

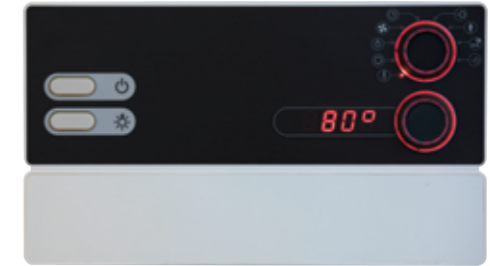

PRO C2

To control the sauna heater, lighting, ventilation and infrared radiators

Item no.

PRO-C2



Datasheet



PRO C3

To control the sauna heater, combi heater, lighting, ventilation, automatic post-drying program and infrared radiators

Item no.

PRO-C3



Datasheet



WiFi capable
S-WIFI-01 as well as door sensor or switch-off rocker for WiFi use required



Experience the sauna with all your senses. With the PRO D series from sentiotec.

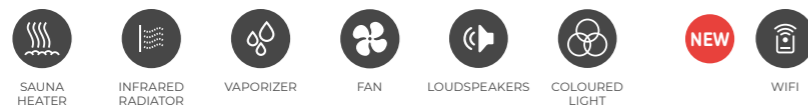

The **PRO D family** from **sentiotec** impresses with its modern and timeless design and can be installed either outside or inside the sauna. In other words, directly in the sauna, right next to you.

The **PRO D2** allows you to easily and conveniently bring your sauna heater to the desired temperature. And if you would like it to be a few degrees warmer, you do not have to get up to make changes. With the **PRO D series**, you can adjust all settings from the bench.

With the **PRO D2i**, you also have the option to place and operate an infrared radiator in your sauna. An additional operating unit can be placed right next to the radiator to control the intensity.



In addition to the functions of the **PRO D2**, the **PRO D3** gives you the option of operating a combi heater and creating a pleasant humidity in your sauna.



PRO D Bluetooth

Sound:

You want to listen to your favourite music, or maybe even make a phone call in the sauna, or communicate with your voice assistant? **PRO D Bluetooth** allows you to connect your mobile phone easily and conveniently and adjust the volume of the music without getting up from the bench.

More on page 90



PRO D DMX

Light:

And if you would like to experience a sunset in the sauna and glow in the reddish light, the **PRO D DMX** puts the full spectrum of colour at your fingertips. This operating unit can also be mounted directly next to you on your favourite side and blends in perfectly with the cabin.

More on page 92



Datasheet PRO D



Datasheet PRO D IP-65



PRO D2, PRO D2i



Innovative technology in the PRO D2:

- 2-part sauna control unit (up to 4 sauna operating units can be used)
- Patented technology
- Installation of the operating unit possible inside and outside the sauna
- Maximum switching load of the heating system: 10.5 kW
- Light and fan switchable and dimmable (max. 100 W)
- Heating time limit can be raised for commercial use (6/12/18/24 h)
- Energy-efficient electronics
- Connection for safety devices or door monitoring
- Single or dual sensor system
- Digital and precise-to-the-minute time preset
- Digital temperature preset and temperature display
- Remote start via potential-free contact
- Eco mode
- Status output
- Connection of an additional power booster (required for electric heaters with outputs of more than 10.5 kW)
- User profiles

Innovative technology in the PRO D2i (in addition to the PRO D2):

- Additional output switchable up to 3.5 kW or 500 W dimmable (for infrared heater, for example, or infrared heater panels)
- Optional: Operating unit for additional output

Optional:

- WiFi capable in connection with the "BUS-CON-D" and "S-WIFI-01" as well as door sensor system (page 41) or switch-off rocker (page 40) capable for WiFi use
- PRO D BUS converter for RS 485 connection for house bus systems
- Power unit featuring a protection class IP65 housing (protection against jets of water)



Optional: PRO D power unit

Can also be installed inside the sauna. Power unit featuring a protection class IP65 housing. The desired operating unit must be ordered separately.

Item no.
PROD-IP65-L



Optional additional output in operating unit

Item no.
PRO-DA-CU
PRO-DAW-CU



PRO D2

Item no.
PRO-D2*
PRO-D2W*
PRO-D2-CU (Additional operating unit)
PRO-D2W-CU (Additional operating unit)



PRO D2i

Item no.
PRO-D2i*
PRO-D2iW*
PRO-D2i-CU (Additional operating unit)
PRO-D2iW-CU (Additional operating unit)



*Standard features of delivery:
Power unit
Protection class: IPX4

PRO D3, PRO D3i



Innovative technology in the PRO D3 (in addition to the PRO D2):

- Maximum evaporator performance: 3.5 kW
- Operation with a real humidity sensor or clocked (Sensor must be ordered separately)
- Post-drying programme
- Digital humidity preset
- Humidity indicator (only with humidity sensor)

Innovative technology in the PRO D3i (in addition to the PRO D3):

- Additional output switchable up to 3.5 kW or 500 W dimmable (for infrared heater, for example, or infrared heater panels)
- Optional: Operating unit for additional output

Optional:

- WiFi capable in connection with the "BUS-CON-D" and "S-WIFI-01" as well as door sensor (page 41) or switch-off rocker (page 40) capable for WiFi use
- PRO D BUS converter for RS 485 connection for house bus systems
- Power unit featuring a protection class IP65 housing (protection against jets of water)



Optional: PRO D power unit

Can also be installed inside the sauna. Power unit featuring a protection class IP65 housing. The desired operating unit must be ordered separately.

Item no.
PROD-IP65-L



Optional additional output in operating unit

Item no.
PRO-DA-CU
PRO-DAW-CU



PRO D3

Item no.
PRO-D3*
PRO-D3W*
PRO-D3-CU (Additional operating unit)
PRO-D3W-CU (Additional operating unit)



PRO D3i

Item no.
PRO-D3i*
PRO-D3iW*
PRO-D3i-CU (Additional operating unit)
PRO-D3iW-CU (Additional operating unit)



*Standard features of delivery:
Power unit
Protection class: IPX4



MySentio

Your **sentiotec** sauna experience is ready when you are.

With the new **MySentio app**, all the sauna functions are in the palm of your hand! The simple control panel allows you to easily set your sauna as required using a mobile device, wherever and whenever you want.

The **MySentio app** controls all types of sauna: conventional saunas, infrared saunas or combinations of the two – hybrid saunas. You can also control the coloured lighting in your sauna.

Many **sentiotec** control units can be easily upgraded to the new technology using **MySentio WiFi** or **MySentio Remote**.

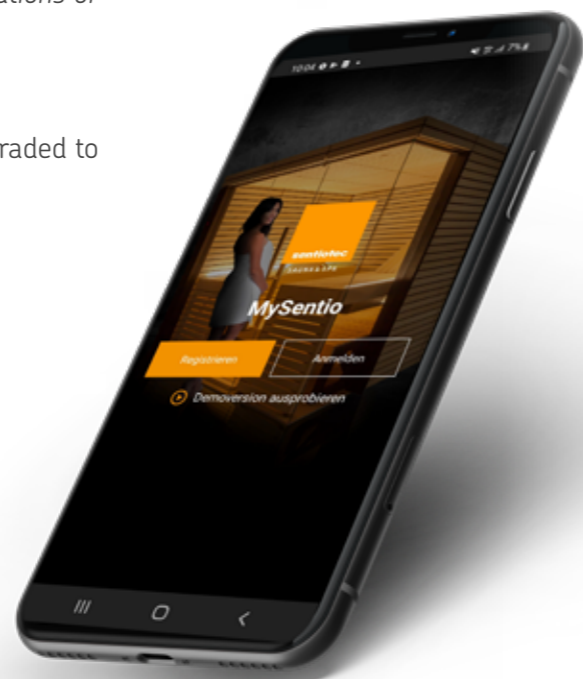

MySentio WiFi

For home.com4 RS485 and PRO series

With **MySentio WiFi**, almost all functions can be comfortably and conveniently used via the MySentio app. To ensure safe operation, appropriate safety precautions must be taken (e.g. Shut-off rocker or door sensor, page 40).



MySentio WiFi
For more information, see page 53

MySentio Remote

For wave.com4 11 kw and sentiotec steam generator (p. 88)

With **MySentio Remote**, you can switch on your sauna with the presets selected via the control unit while you are out of the house. For safe operation, you need the following accessories: Shut-off rocker or door sensor system, page 40.



MySentio Remote
For more information, see page 54

MySentio WiFi

The most convenient way to operate your sauna when away from home. All functions in one app.

Innovative technology:

- Plug & Play
- WiFi dongle*
- User-friendly control with a mobile device
- The app can be downloaded for mobile devices in the Apple App Store or Google Play Store. (Demo version included)
- All functions of the connected sauna control unit**
- Control of temperature and humidity
- Control of infrared radiators
- Control of the coloured LED lighting
- Control of a light source
- Control of the fan
- Multiple user programs
- Low power technology

*The WiFi dongle is connected to the control unit by means of a network cable and must be within range of your network (WLAN).
For the **PRO D series**, an additional **BUS converter** is necessary.



MySentio WiFi
Item no. S-WIFI01 / 1-053-313

Can also be retrofitted for existing controllers (downward compatible).
More detailed information can be found here:



Datasheet

**Compatible devices / functions:

	Sauna temperature	Humidity	Infrared (additional output)	Coloured light	Light switchable	Light dimmable	Fan switchable	Fan variable	Operating time	User program
home.com4 RS485	X	X	X	X	X		X		X	X
PRO B2	X				X				X	
PRO B3	X	X			X				X	
PRO C2	X		X		X	X	X	X	X	X
PRO C3	X	X	X		X	X	X	X	X	X
PRO D2	X				X	X	X	X	X	X
PRO D2i	X		X		X	X	X	X	X	X
PRO D3	X	X			X	X	X	X	X	X
PRO D3i	X	X	X		X	X	X	X	X	X



MySentio Remote set

Start your sauna and steam bath while out and about.

Innovative technology:

- Mobile use and cloud technology
- WiFi connected (easy connection and setup)
- Status functions available (switched on)
- For all control units with potential-free remote start input (sauna, infrared and steam bath control units)

Operating a sauna heater using a remote start function requires appropriate safety precautions to be taken (e.g. safety shutdown or door monitoring)



Datasheet



Installation box

Relay box

To generate extended functions (e.g. switching on an external device), the relay box can be connected between the sauna control unit and the WiFi dongle.



Installation box

Dongle

App

Configurable switching functions

- External device on when heater is on
- External device on when light is on
- External device on when there is a lack of water
- External device on when there is an error



Connectivity overview home.com4 & PRO Series

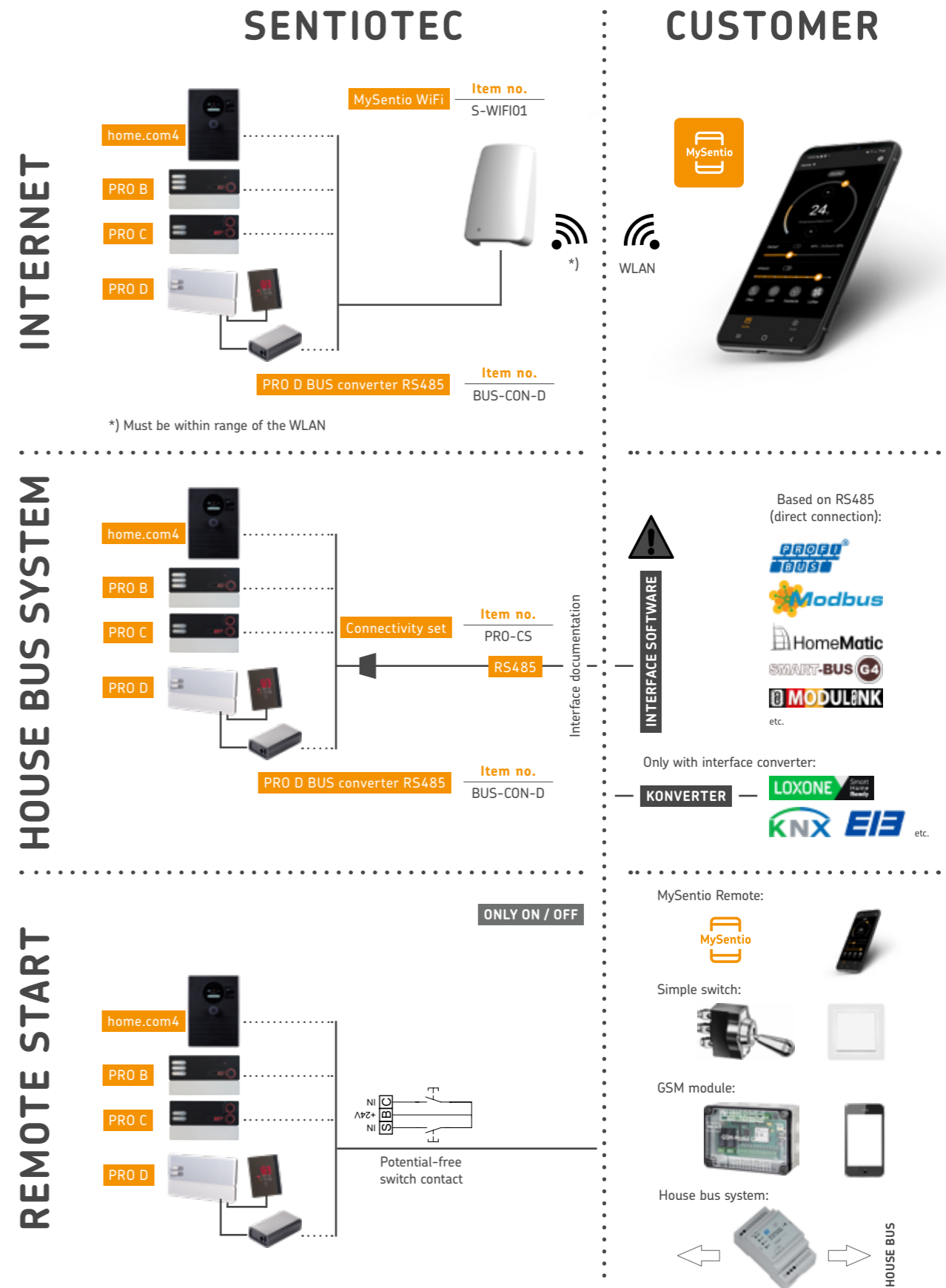

wave.com4 11 kW



Operating unit for basic & humidity module
The patented interior & exterior operating unit in the innovative wave design.

Innovative technology:

- Patented technology – installation possible inside and outside the sauna
- Flat mounting in the cabin (only 10 mm visible)
- Temperature resistant up to 120 °C
- Moisture-proof
- Easy-view display (large 7-segment display)
- Several operating units (up to four) can be connected to the same power supply unit
- Easy mounting with standard core drill
- Various colour and material variations available
- Digital temperature readout on the operating unit
- Ideal for outdoor saunas



Basic & humidity module

The wave.com4 leaves nothing to be desired. The modular power supply unit offers all conventional functions. You decide how your sauna is equipped – wave.com4 makes it possible!

Innovative technology (basic module):

- Protection class: IP65
- Remote start with optional door monitoring
- Modular, expandable control system
- Temperature setting from 30 to 110 °C (in 1 °C increments)
- Programmable special functions
- Dimmable lighting, phase control
- Several operating units can be connected to the same power supply unit (wave.com4 operating units must be ordered separately)
- Separate heating and lighting circuit (EN 60335-2-53 & EN 60335-1)
- Safety temperature limitation
- Heating time limit from 1 to 12 hours can be selected
- Preset time from 1 to 24 h
- Automatic fault detection (damaged sensor, sensor short-circuit, etc.)
- Menu in several languages
- Eco mode



Item no.

WC4-B-D

WC4-B-S



Datasheet



Basic module:

Item no.

WC4-B-11

Humidity module:

Item no.

WC4-H-PCB

NOTE: Heater sensor F1, bench sensor F2 and humidity-temperature sensor (FTS2) must be ordered separately. (See page 55)

K1-NEXT



Datasheet

Top quality at a great price.
The first step to sauna enjoyment.

Innovative technology:

- One-piece housing with integrated control unit
- Temperature progressively adjustable from 40 °C to 125 °C
- Temperature and safety sensor for the heater
- Switches off on sensor interruption and short circuit
- Heating time limit 6 hours
- Light connection
- One-sensor system



Item no.

K1-9-N

K2-NEXT



Datasheet

Digital display. Despite full functionality with timer and digital display at a low price.

Innovative technology (in addition to K1-NEXT):

- Digital display: Enter the preset time (in 15 minute intervals)



Item no.

K2-9-N

K3-NEXT



Datasheet

With humidity module

This control unit combines sauna and humidity operation at a high level of quality at a low price.

Innovative technology (in addition to K2-NEXT):

- Humidity operation, selectable temperature from 40 °C to 65 °C
- Evaporator output: 3 kW
- Low-water display
- Acoustic signal
- Temperature and humidity mode display, as well as preset time in 15-minute increments
- Two-sensor system



Item no.

K3-9-N

K4-NEXT

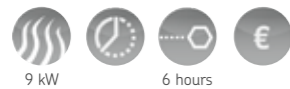

With temperature display
Even with full functionality including timer and digital temperature display, this comes at a low price.

Innovative technology (in addition to K1-NEXT):

- Digital temperature display
- Digital display: Entering the preset time (up to 24 hours, accurate to the minute)
- Optical fault display



Datasheet



Item no.

K4-9-N

Power booster



Additional power unit for expanding the output range of the control units.

- 0-S2-18 can also control 9 kW
- 0-S2-18S in addition to S2-18: low-noise
- 0-S2-30 can also control 21 kW



Item no.

0-S2-18

0-S2-18S

0-S2-30



Datasheet

Sensor



Sensor F1
Heater sensor, 1.5 m cable length
Item no. 0-F1



Sensor F2
Bench sensor, 1.5 m cable length
Item no. 0-F2



Sensor FTS2
Humidity temperature sensor,
6 m cable length
Item no. 0-FTS2



Datasheet

Accessories

Optional wooden housing for sensors of the A series, K series and C series



Wooden housing for F1 and F2 sensors
Item no. SC-F1F2-H (light)
Item no. SC-F1F2-D (dark)



Wooden housing for FTS2 sensors
Item no. SC-FTS2-H (light)
Item no. SC-FTS2-D (dark)





SAUNA ACCESSORIES

<i>Thermometer/hygrometer</i>	62
<i>Buckets & ladles</i>	63
<i>Hourglasses</i>	64
<i>Sauna doors</i>	64
<i>Accessories</i>	64
<i>Lamps</i>	65
<i>Head- and backrests</i>	65
<i>Heater protection grille</i>	66
<i>Fountain shower</i>	66
<i>Fragrance bowl</i>	66
<i>Other products</i>	66
<i>Sauna accessories Basic</i>	67
<i>Serenity bench</i>	68
<i>Ergonomic sauna bench</i>	68
<i>Menthol crystals</i>	69
<i>Sauna peeling salts</i>	69
<i>Sauna scent concentrates</i>	69

Thermometer/hygrometer

Temperature and humidity measuring instruments



Thermometer and hygrometer
Diameter 150 mm
Item no. A-210-THW



Thermometer/hygrometer
Diameter 130 mm
Item no. 260-TH-OD



Thermometer
230 x 230 x 30 mm (W x H x D)
Item no. 220-TP (softwood)



Square thermometer
Item no. 223-TA (aspen)
Item no. 223-TD (red cedar)



Square thermometer/hygrometer
Item no. 225-THA (aspen)
Item no. 225-THD (red cedar)



Square thermometer/hygrometer, divided
Item no. 224-THA (aspen)
Item no. 224-THD (red cedar)



Thermometer/hygrometer
225 x 140 mm (W x H)
Item no. 221-THA (aspen)
Item no. 221-THD (red cedar)
Item no. 221-THP (softwood)



Thermometer/hygrometer
Curved housing
Item no. 271-THBP

Buckets & ladles

Relaxing infusion



Premium black sauna accessories
Bucket and ladle, 4 l
Item no. A-10111



Red cedar sauna bucket, 4 l
with plastic inner liner
Item no. 340-D



Sauna bucket, 4 l
with plastic inner liner
Item no. 340-P



Sauna bucket, 3 l
with plastic inner liner
Item no. 330-P



Professional sauna ladle
with stainless steel insert
Item no. 341-MP (3 L)



Plastic inner liner, 4 l
Item no. 304
Plastic inner liner, 3 l
Item no. 303



Stainless steel bucket, 5 l
with curved aspen and red cedar handle
Item no. 373-MA
373-MD (red cedar)



"Steamwater" bucket, 4 l
Black
Item no. 342-BL



"Steamwater" bucket, 4 l
Red cedar
Item no. 342-D



Stainless steel ladle
with curved aspen
and red cedar handle, 100 ml
Item no. 453-MA
Item no. 453-MD (red cedar)



"Steamshot" ladle, 49 cm
100 ml
Item no. 449-BL (black)
Item no. 449-D (red cedar)



Wooden spoon 41 cm
100 ml
Item no. 440-B
Item no. 440-D (red cedar)



Ladle 40 cm
Stainless steel with wooden handle, 100 ml
Item no. 441-MP
Item no. 441-MD (red cedar)



Ladle 40 cm
Stainless steel with wooden handle, 200 ml
Item no. 442-MP
Item no. 442-MD (red cedar)



Hourglasses

Perfect timing



Hourglass
15 minutes
Item no. 553-A (aspen)
Item no. 553-D (red cedar)

Red cedar hourglass
15 minutes
65 x 340 mm (W x H)
Item no. 551-D



Aspen hourglass
15 minutes
65 x 300 mm (W x H)
Item no. 551-A

Softwood hourglass
15 minutes
65 x 340 mm (W x H)
Item no. 551-EP



Softwood hourglass
15 minutes
65 x 340 mm (W x H)
Item no. 551-P

Sauna doors

Feel-good ambience



DS80 sauna door
3-sided frame, clear glass or bronze
8 mm single pane safety glass,
hinges can be attached on left or right
Glass: 590 or 680 x 1915 mm
Spruce frame: 650 or 740 x 1960 x 80 mm
Item no. DS80-3CS-590 (clear, 590 mm)
Item no. DS80-3BS-590 (bronze, 590 mm)
Item no. DS80-3CS-680 (clear, 680 mm)
Item no. DS80-3BS-680 (bronze, 680 mm)



DS80 sauna door, clear class
3-sided frame, 8 mm single pane
safety glass, hinges can be attached
on left or right
Glass: 824 x 1997 mm
Spruce frame: 920 x 2060 x 80 mm
Item no. DS80-3CS-824 (824 mm)



DS40 sauna door
3-sided frame, clear glass 8 mm ESG,
Hinges can be attached on the left or right
Glass: 590 or 680 x 1915 mm
Spruce frame: 650 or 740 x 1960 x 40 mm
Item no. DS40-3CS-590 (590 mm)
Item no. DS40-3CS-680 (680 mm)

Accessories

Further accessories
can be found in the price list

For sauna doors



**Door hinge glass/glass
rectangular**
Item no. DH-GG-A
(stainless steel)
Item no. DH-GG-SZ



**Door hinge glass/wood
rectangular**
Item no. DH-GW-A
(stainless steel)
Item no. DH-GW-SZ

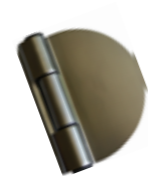

**Glass door hinge,
semi-circular**
Item no. DH-SC



Linden door handle
Hole spacing 20 cm
Item no. 562-L



**Wood/stainless steel
door handle**
Hole spacing 20 cm
Item no. 564-B

Lamps

Pleasant lighting



Sauna lamp cover
also for corner mounting
Item no. 915-VP



Sauna lamp cover
Item no. 917-A (aspen)
Item no. 917-D (red cedar)



Sauna lamp cover
150 x 305 x 10 mm (W x H x D)
Item no. 913-VP



Sauna lamp cover
also for corner mounting
207 x 280 mm (W x H)
Item no. 914-VP



Sauna lamp cover
only for corner mounting
Item no. 920-L (linden)



Sauna lamp IP54 40 W
(Suitable for all covers,
except 915-VP)
Item no. A-910

Head- and backrests

Comfort & ergonomics



Ergonomic Wave headrests
for the greatest possible relaxation in the sauna
Item no. 515-A (aspen)
Item no. 515-D (red cedar)



Ergonomic headrests
Item no. 512-A (aspen)
Item no. 512-D (red cedar)



Headrest
370 x 275 mm (W x H)
Item no. 510-P (softwood)



Wave headrest
370 x 270 mm (W x H)
Item no. 511-P



Headrest
Item no. 520-L (linden)



Backrest
Item no. 516-P (softwood)



Wave-shaped backrest
Item no. 506-2-D
Item no. 506-2-A



Heater protection grille

For your protection



Prestige heater safety guard
570 x 480 x 760 mm
Item no. SG-PR-S (spruce)
Item no. SG-PR-L (linden)



Emotion heater safety guard
570 x 480 x 580 mm
Item no. SG-EM-S (spruce)
Item no. SG-EM-L (linden)

Fountain shower



Fountain shower, 18 l
with plastic inner liner
Item no. 393-A

Fragrance bowl



Fragrance bowl 12 cm & 20 cm
Item no. DS-12 (Ø 12 cm)
Item no. DS-20 (Ø 20 cm)

Other products

From head to toe



Ventilation slit, rectangular
215 x 170 mm (W x H)
Item no. 620-A (aspen)
Item no. 620-P (softwood)
Item no. 620-D (red cedar)



Ventilation slit, round
Ø 145 mm
Item no. 631-A (aspen)
Item no. 631-P
Item no. 631-D (red cedar)



Sauna air humidifier
Item no. HP01-070 (cylindrical)
Item no. HP01-071 (rectangular)



Soapstone infusion bowl, bulbous
Item no. R-160



Protective box for sauna control unit
lockable, 350 x 400 x 200 mm
Item no. SK-SS-35/40/20



LED protective box
Item no. LED-PB-TP

Sauna accessories Basic

Low-price accessories



Thermometer/hygrometer
Basic version
Item no. 281-THEP



Thermometer/hygrometer
Basic, diameter 100 mm
Item no. 260-TH



Thermometer
Basic, diameter 100 mm
Item no. 260-T



hygrometer
Basic, diameter 100 mm
Item no. 260-H



Wooden hourglass
Basic version
Item no. 552-EP



Wooden ladle
Basic version
Item no. 430-E



Sauna bucket, 4 l
Plastic inner liner
Item no. 335-EP



Sauna accessories box
11-piece; consisting of:
Sauna bucket (with plastic insert), wooden ladle,
hourglass, thermometer/hygrometer,
5 sauna fragrances and sauna rules board
Item no. German: A-453-B-D / Item no. English: A-453-B-E
Item no. French: A-453-B-F / Item no. Italian: A-453-B-I
Item no. Dutch: A-453-B-NL



Sauna accessories box
5-piece; consisting of:
Sauna bucket (with plastic insert),
wooden ladle, hourglass,
thermometer/hygrometer
Item no. A-500-B



Sauna fragrant oil set, 5-piece
with mint, orange, eucalyptus,
pine needle and lemon balm scents
Item no. A-508-B



Sauna rules sign (A4)
Item no. German: A-950-D
Item no. English: A-950-E
Item no. French: A-920-F
Item no. Dutch: A-950-NL



Serenity bench



"Linea" serenity bench
Ergonomic serenity bench. Lie down and feel good. Material: Linden
Dimensions: 206 x 65 mm
Item no. RC-L-H

Ergonomic sauna bench

The "Fibuflex" ergonomic sauna bench is a space-saving design and is also suitable for small sauna cabins. Whether you prefer the bench in a sitting position or you prefer to relax in a reclined position, the choice is yours. The head and lumbar pieces can be individually positioned. You can assemble the "Fibuflex" sauna bench yourself in just a few steps.



Ergonomic sauna bench Fibuflex (aspen)
Dimensions: Back section 460 x 700 x 500 mm
Base section: 460 x 560 x 120 mm
Item no.: 504-A

Menthol crystals



Menthol sauna crystals
Item no. A-110-M (50 g)
Item no. A-111-M (200 g)

Use: All it takes is one tiny crystal in the infusion water or placed directly onto the hot sauna stones to reveal the refreshing properties of these crystals. The pleasant menthol scent of the peppermint clears the airways.

Sauna peeling salts



Use: In the sauna, rub it into moist skin. Made from sea salt.



Eucalyptus menthol

Promotes perspiration and cools the skin
Item no. A-200-EM (200 g)
Item no. A-201-EM (1 kg)



Honey

Promotes perspiration
Item no. A-200-HO (200 g)
Item no. A-201-HO (1 kg)



Lavender mint menthol

Promotes perspiration and cools the skin
Item no. A-200-LM (200 g)
Item no. A-201-LM (1 kg)

Sauna scent concentrates

Fragrant essences



Alpine herbs

Fresh, strong and clear scent. Creates an atmosphere of depth and determination
Item no. A-100-AK (100 ml)
Item no. A-102-AK (1 l)
Item no. A-103-AK (10 l)



Blood orange

A fruity and fresh aroma, boosts concentration, stimulating and harmonising
Item no. A-100-BO (100 ml)
Item no. A-102-BO (1 l)
Item no. A-103-BO (10 l)



Citrus lemon

Refreshing, reviving and cool fragrance, invigorating, stimulating; tangy and sour, boosts creativity
Item no. A-100-CL (100 ml)
Item no. A-102-CL (1 l)
Item no. A-103-CL (10 l)



Sauna scent concentrates

Fragrant essences



Wild service tree berries

A fruity and fresh aroma, cooling and harmonising
Item no. A-100-EB (100 ml)
Item no. A-102-EB (1 l)
Item no. A-103-EB (10 l)



Ice cherry

Sweet/aromatic smell, calms anxiety, enhances well-being, stimulates
Item no. A-100-EK (100 ml)
Item no. A-102-EK (1 l)
Item no. A-103-EK (10 l)



Ice mint

Provides a cool atmosphere, increases well-being, cleansing, stimulating, cooling effects
Item no. A-100-EM (100 ml)
Item no. A-102-EM (1 l)
Item no. A-103-EM (10 l)



Mint/lemon

A fruity and fresh aroma, cooling and harmonising
Item no. A-100-MZ (100 ml)
Item no. A-102-MZ (1 l)
Item no.: A-103-MZ (10 l)



Nordic birch

Stabilising, stimulating and harmonising
Item no. A-100-NB (100 ml)
Item no. A-102-NB (1 l)
Item no. A-103-NB (10 l)

NEW



Peppermint, pine, incense and myrrh

Light, fresh scent, analgesic and anti-inflammatory
Item no. A-100-PM (100 ml)
Item no. A-102-PM (1 l)

NEW



Eucalyptus, blackcurrant, lavender and cedarwood

Refreshing scent, helps against stress and promotes inner peace, has a cleansing effect
Item no. A-100-EZ (100 ml)
Item no. A-102-EZ (1 l)



Spice mint

Mostly mint with a slight hint of eucalyptus rounded off with spicy clove and cinnamon, harmonising, stimulating
Item no. A-100-GM (100 ml)
Item no. A-102-GM (1 l)
Item no. A-103-GM (10 l)

NEW



Pomegranate, mint and incense

Refreshing sweet scent, stimulating and invigorating
Item no. A-100-GW (100 ml)
Item no. A-102-GW (1 l)



Royal Eucament

This fragrance contains eucalyptus, mint, menthol, camphor and sage with soothing and harmonising effects, cools and boosts well-being
Item no. A-100-RE (100 ml)
Item no. A-102-RE (1 l)
Item no. A-103-RE (10 l)



Sea buckthorn

A tangy, fresh and fruity aroma, invigorating.
Item no. A-100-SD (100 ml)
Item no. A-102-SD (1 l)
Item no. A-103-SD (10 l)



Sauna gold

Spicy aroma, with soothing and harmonising effects
Item no. A-100-SG (100 ml)
Item no. A-102-SG (1 l)
Item no. A-103-SG (10 l)



Elderberry and plum

A tangy, fresh and fruity aroma, elderberry is a traditional medicine and strengthens the immune system
Item no. A-100-HZ (100 ml)
Item no. A-102-HZ (1 l)
Item no. A-103-HZ (10 l)



Honey

Invigorating, stimulating, spicy aroma
Item no. A-100-HO (100 ml)
Item no. A-102-HO (1 l)
Item no. A-103-HO (10 l)

NEW



Jasmine, blood orange and pepper

Stimulating yet calming scent, has a relaxing effect
Item no. A-100-JP (100 ml)
Item no. A-102-JP (1 l)



Cedar Euca Orange

A fruity, fresh and rounded fragrance, harmonising, with cleansing, stimulating, cooling effects
Item no. A-100-ZE (100 ml)
Item no. A-102-ZE (1 l)
Item no. A-103-ZE (10 l)

NEW



Cedar, may chang and mint

Stimulating cooling scent, has a relaxing effect
Item no. A-100-ZP (100 ml)
Item no. A-102-ZP (1 l)



Lemon grass

Strong, fresh citrus aroma, stimulating and invigorating, relieves fatigue and improves concentration
Item no. A-100-LG (100 ml)
Item no. A-102-LG (1 l)
Item no. A-103-LG (10 l)



Mixed herbs

Fresh, strong and clear scent; creates an atmosphere of depth and decisiveness, reviving and refreshing
Item no. A-100-KM (100 ml)
Item no. A-102-KM (1 l)
Item no. A-103-KM (10 l)



Mountain pine

Resinous wood aroma, refreshing, invigorating and clears the airways
Item no. A-100-LK (100 ml)
Item no. A-102-LK (1 l)
Item no. A-103-LK (10 l)



Lavender

An aroma that opens the senses, for love, friendship and harmony, calming and relaxing
Item no. A-100-LA (100 ml)
Item no. A-102-LA (1 l)
Item no. A-103-LA (10 l)



Swiss pine

Warm, balmy, spicy aroma, cleansing, activating, energising, brightens up your mood
Item no. A-100-ZI (100 ml)
Item no. A-102-ZI (1 l)
Item no. A-103-ZI (10 l)

NEW



Swiss pine, bergamot and may chang

Fresh fragrance, positively stimulating and calming, reduces stress and anxiety
Item no. A-100-ZL (100 ml)
Item no. A-102-ZL (1 l)



100 ml

1 l

10 l





INFRARED

<i>Infrabox basic S / Infrabox</i>	74
<i>Pro D infra</i>	75
<i>Infrared overview: Two-circuit</i>	76
<i>Infrared overview: Single-circuit</i>	77
<i>wave.com4 infra</i>	78
<i>IS1</i>	79
<i>switchbox</i>	79

Infrabox basic S / Infrabox



3.5 kW

The Infrabox is a versatile, modern, digital control unit for infrared saunas and infrared radiators. The stylish, unobtrusive yet clear control panel can be easily mounted where it is needed.

It is particularly user-friendly thanks to the LED displays on the control panel. The Infrabox allows you to control the duration, the infrared radiators and the lighting.

Innovative technology of the Infrabox basic S:

- Suitable for infrared heating systems with an IR radiator, IR foils, or IR plate technology
- One heating output: dimmable in five levels (max. 1300 W) or switchable to max. 3500 W
- Foil temperature monitoring (sensor optional)
- Remote start / enabling input
- A variety of individual setting options using dip switches
- Heating time limit (duration) can be extended (6 h standard, extendable to 12 or 24 h)
- Optional: Safety temperature limiter
- Available in black and white
- Optional seat sensor: switches on the heating device when approached



Item no.

IRB-B-S-S
(infrabox basic S, black)

IRB-B-W-S-S
(infrabox basic S, white)



Datasheet



Item no.

IRB-S (black)

IRB-W-S (white)



Datasheet

Innovative technology of the Infrabox (in addition to Infrabox basic S):

- Dimmable light output (max. 100 W)

Pro D infra



3 kW

The all-rounder among the infrared control units!

Innovative technology:

- Suitable for infrared heating systems with IR radiators, IR foils or IR plate technology
- Control in power levels (also for full-spectrum radiators, such as Vitae)
- Two separately controllable heating circuits each with two outputs of 1500 W (max. 3000 W)
- Bench sensor included
- Operating unit in PRO D design (must be ordered separately)
- Digital display of heating time, intensity levels or temperature
- Predefined user programs (relaxation, warming, short and long endurance)
- Cascadable power supply units up to 12 kW, option of connecting multiple radiators
- Multiple operating units can be connected to a power supply unit
- Heating time limit can be extended (6 h standard, extendable to 12 or 24 h)
- Two switchable additional outputs
- Can be operated from inside and outside
- Heat and moisture-proof product
- Power unit also available as a dimmable version only



Item no.

WC4-PRODI-B

WC4-PRODI-W



Datasheet



Item no.

WC4-IRX-P

VITAMY-WC4-IRX
(dimmable only)

Infrared overview: Two-circuit

Operating type: Temperature, intensity, program

PRO D
Infra set

Item no.
SET-PRODI-B
SET-PRODI-W



incl.
Power unit WC4-IRX-P (2 x 1500 W / 4 outputs)
Mains connection cable IR-CP-EU
Temperature sensor 0-F2
Light plug WC4-P-LI

To increase the maximum connection rating (3 kW), it is possible to control two or more (up to 5) power units with one control unit.

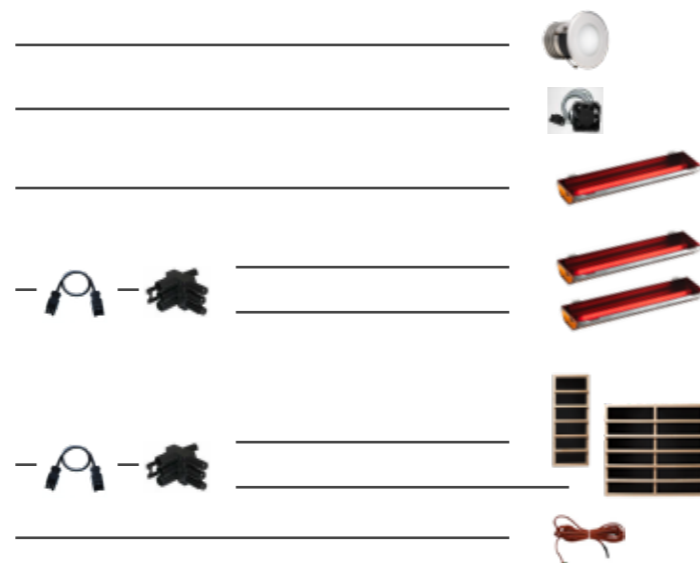

Operating type: Intensity

PRO D
Infra set

Item no.
SET-PRODI-BD
SET-PRODI-WD



incl.
Power unit VITAMY WC4-IRX dimmable only (2 x 1500 W / 4 outputs)
Mains connection cable IR-CP-EU
Light plug WC4-P-LI

To increase the maximum connection rating (3 kW), it is possible to control two or more (up to 5) power units with one control unit.

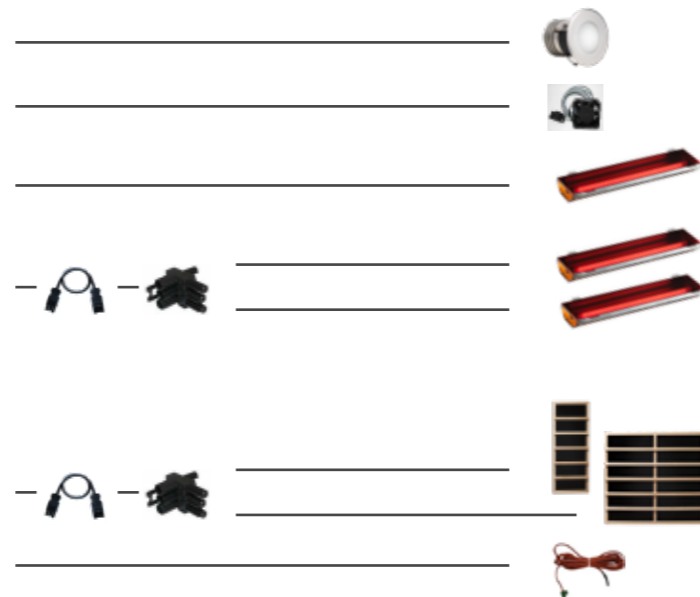

IR radiators	IR radiators	Heat plates	LED spotlight	Plug light	Fan
Item no. DIR-...-R WIR-...-G 350, 500, 750, 1300 W	Item no. ECO-...-R ECO-...-G 350, 500, 750 W	Item no. IR-WPHL-... IR-WP-... 100, 175, 390, 510 W	Item no. LED-SP-WW-... 2 W / 5 W Light Incandescent bulb max. 100 W	Item no. WC4-P-LI	Item no. WC4-IRX-FAN Dimmable to max. 100 W

Infrared overview: Single-circuit

Operating type: Intensity

Infrabox set

Item no.
IRB-S
IRB-W-S

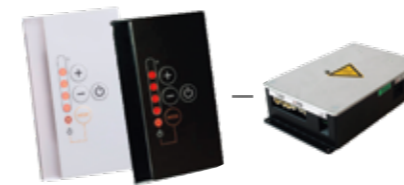

incl.
Power unit
(1 output / max. 3500 W or dimmable to 1300 W)
Mains connection cable

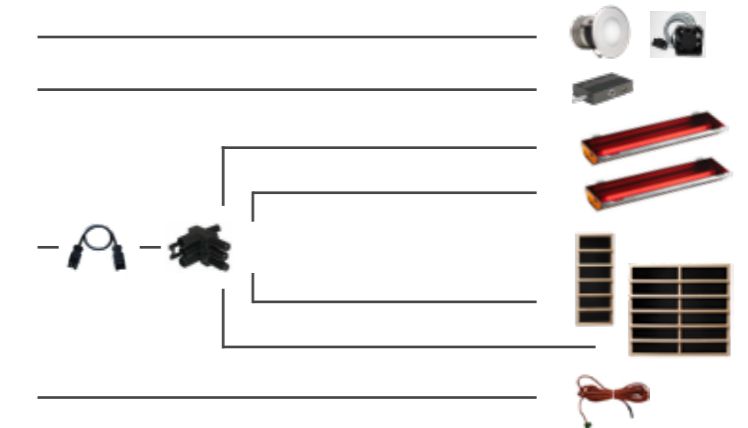

Operating type: Intensity

Infrabox
basic S set

Item no.
IRB-B-S-S
IRB-B-W-S-S



incl.
Power unit
(1 output / max. 3500 W or dimmable to 1300 W)
Mains connection cable

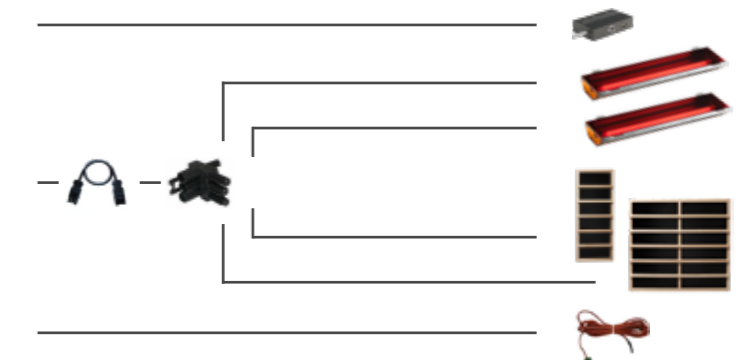

Operating type: Temperature

IS1

Item no.
P-IS1-T



Single-component control unit
(1 output / max. 3000 W)
incl. temperature sensor

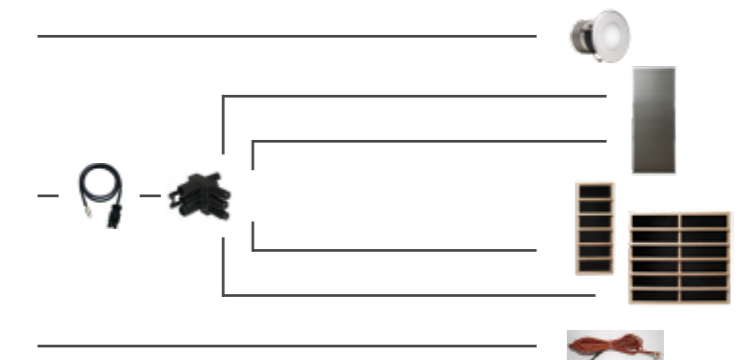

Seat sensor	Infrared distributor	Connection cable	Connection cable	Foil sensor WC4	Foil sensor IS
Item no. IRB-F-S	Item no. IR-1P2 IR-1P3 IR-1P5	Item no. WC4-GST-C05 (0.5 m)	Item no. IR-IS-A03 (0.3 m) IR-IS-A10 (1.0 m) IR-IS-A25 (2.5 m)	Item no. WC4-IRF-F When using heating plates	Item no. P-ISX-FF When using heating plates

wave.com4 infra



Infrared operating unit - wave.com4 infra
The all-rounder among the infrared control units!

Innovative technology:

- Suitable for infrared heating systems with IR radiators, IR foils or IR plate technology
- Control in power levels (also for full-spectrum radiators, such as Vitae)
- Two separately controllable heating circuits each with two outputs of 1500 W (max. 3000 W)
- Bench sensor included
- Operating unit in wave.com4 design (must be ordered separately)
- Digital display of heating time, intensity levels or temperature
- Predefined user programs (relaxation, warming, short and long endurance)
- Cascadable power supply units up to 12 kW, option of connecting multiple radiators
- Multiple operating units can be connected to a power supply unit
- Heating time limit can be extended (6 h standard, extendable to 12 or 24 h)
- Two switchable additional outputs
- Can be operated from inside and outside
- Heat and moisture-proof product
- Power unit also available as a dimmable version only



Item no.

WC4-IRX-D

WC4-IRX-S



Datasheet



Item no.

WC4-IRX-P

VITAMY-WC4-IRX
(dimmable only)

IR power
supply unit



IS1



Greatest flexibility
IS1 Professional infrared – single-component basic infrared control units.

Innovative technology IS1:

- Professional, basic infrared control unit at a low price
- Mains connection cable 16 A, 230 V
- Single-circuit infrared control unit with temperature control
- One heating output max. 3000 W
- Optional interior temperature control for radiators or heating foils
- Foil temperature monitoring
- Switching cabin lighting on/off
- Optional: Safety temperature limiter



Item no.

P-IS1-T



Datasheet

switchbox



Intelligent switching device for wellness facilities.

Innovative technology:

- Operating unit for external and internal installation
- Can be used as button, switch & timer with status display
- Direct operation of intrinsically safe heaters possible, e.g. infrared radiators, etc.
- Remote start & remote stop
- Automatic sauna sprinkler, automatic fans connectable, etc.
- A variety of individual setting options using dip switches
- Max. switching load 3000 Watt, AC1



Item no.

WC4-SB-D



Datasheet



HEATERS & ACCESSORIES

RADIATORS

<i>Vitae full spectrum radiator</i>	82
<i>Nextrema full spectrum radiator, white</i>	83
<i>ECO full-spectrum radiators</i>	84
<i>Infrared heating plates</i>	84

ACCESSORIES

<i>Accessories for radiators</i>	85
<i>Ergonomic backrests</i>	85
<i>Infra scented gel</i>	85

Vitae full spectrum radiator



350 – 1300 W

Maximum power immediately.
The effective use of the radiant heat is made possible by the Vitae infrared radiators.

Innovative technology:

- No pre-heating, the maximum output is immediately available
- Intrinsically safe due to overtemperature protection
- Heat-resistant glass ceramic cover
- Very good, uniform heat distribution due to built-in reflector
- Optional: decorative panel in black or stainless steel (see Fig.) or wooden lattice to 500 Watt
- Offers the degree of protection IPX4 (suitable for saunas) in the installed state in combination with the front panels or wooden backrests
- Available in 350, 500, 750 and 1300 W
- Infrared radiator: A 24%, B 55%, C 21%

* Front panels and wooden lattice are not included in the scope of delivery and must be ordered separately. (see page 85)

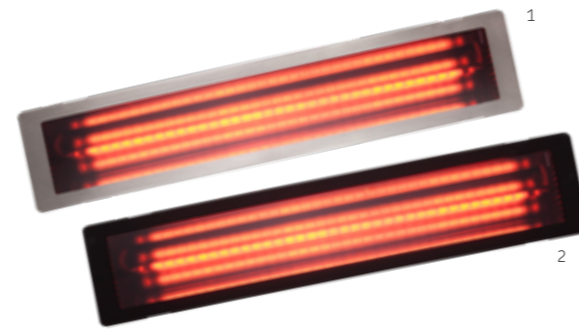

Figure 1: Spotlight with decorative brushed stainless steel trim*

Figure 2: Spotlight with decorative black finish stainless steel trim*

Item no.

DIR-350-R

DIR-500-R

DIR-750-R

DIR-1300-R

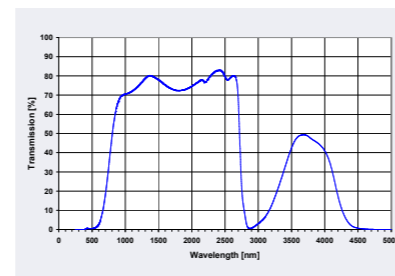

Radiation transmissible dark glass



Datasheet

Nextrema full spectrum radiator, white



350 – 750 W

Mild infrared radiator.
The white filter glass made of three-fold fired glass ceramics reduces the spectral components which, due to interaction with water molecules in the skin, would otherwise place an undesirable thermal load on the uppermost layer of skin.

Innovative technology:

- Infrared A filter
- Mild infrared emission for the body and gentle heat due to filtering out of the microwave radiation
- No pre-heating, the maximum output is immediately available
- Intrinsically safe due to overtemperature protection
- Heatproof glass ceramic covering
- Very good, uniform heat distribution due to built-in reflector
- Optional: dark or stainless steel decorative panel (see Fig.) or wooden lattice to 500 Watt
- Offers the degree of protection IPX4 (suitable for saunas) in the installed state in combination with the front panels or wooden backrests
- Available in 350, 500 and 750 W
- Infrared radiator: A 9%, B 57%, C 34%

* Front panels and wooden lattice are not included in the scope of delivery and must be ordered separately. (see page 85)

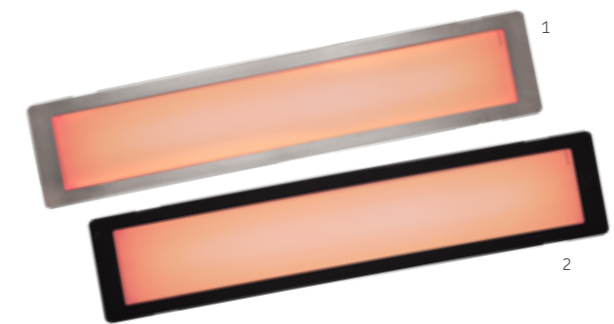

Figure 1: Spotlight with decorative brushed stainless steel trim*

Figure 2: Spotlight with decorative black finish stainless steel trim*

Item no.

WIR-350-R

WIR-500-R

WIR-750-R

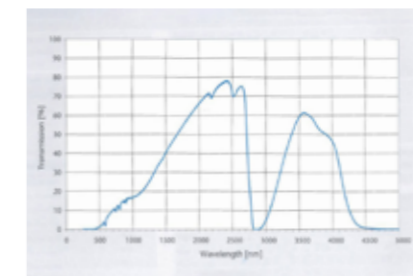

Radiation transmissible white glass



Datasheet

ECO full-spectrum radiators



350 – 750 W

Maximum power without pre-heating
ECO full-spectrum radiator – effective in price and performance

Innovative technology:

- No pre-heating, the maximum output is immediately available
- Intrinsically safe due to overtemperature protection
- Very good, uniform heat distribution due to built-in reflector
- As installed, in combination with front panels or wooden backrests, the glass version offers IPX4 protection (suitable for saunas), the lattice version IPX2 protection (suitable for infrared cabins)
- Optional: Decorative panel in brushed stainless steel or black, painted stainless steel, wooden grilles can be used for radiators up to 500 W
- Infrared radiation with glass: A 24%, B 55%, C 21%
- Infrared radiation with lattice: A 14%, B 40%, C 46%

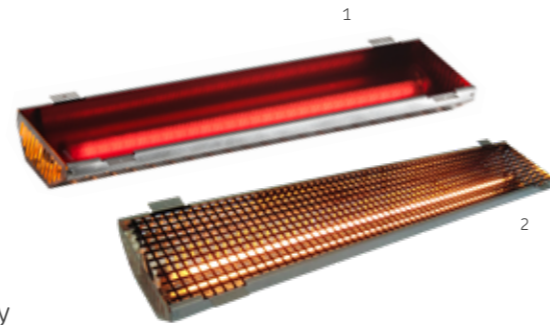

Figure 1:
ECO radiator
with glass

Figure 2:
ECO radiator
with lattice

Item no.	Item no.
ECO-350-R	ECO-350-G
ECO-500-R	ECO-500-G
ECO-750-R	



Datasheet

Infrared heating plates



100 – 510 W

Panel heating
Infrared heating plates ensure an all-round pleasant, relaxing sensation of warmth.

Innovative technology:

- Available from 100 W to 510 W
- Panel heating for infrared and sauna cabins
- Emits in the long-wave infrared range
- Can be combined with full spectrum radiators
- Easy assembly
- Suitable for all sentiotec infrared control units
- Heating plates available in two versions (with or without wooden lattice)
- Insulated rear side ensures energy-efficient heat emission towards the front
- Requires no ventilation
- Optional: plate module, suitable as lower-leg-level radiator

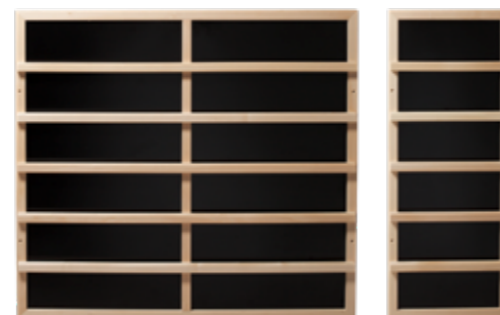

Without backrest:	With backrest:
Item no. IR-WP-100	Item no. IR-WPHL-100
IR-WP-175	IR-WPHL-175
IR-WP-390	IR-WPHL-390
IR-WP-510	IR-WPHL-510



Datasheet

Accessories for radiators

*When using sentiotec infrared radiators, an additional stainless steel front cover is recommended.

Pure infrared



Wooden backrest for IR radiators
73.5 x 21 x 5 cm
Item no. HL-IR-S (350 W)
88.5 x 21 x 5 cm
Item no. HL-IR-L (500 W)



stainless steel bezel for IR radiators
Powder-coated stainless steel
Item no. VIT-BB-S (350 W) -
72.7 x 19.1 x 0.1 cm
Item no. VIT-BB-L (500 W) -
89.2 x 19.1 x 0.1 cm

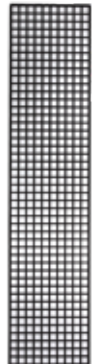

Lattice for Eco full-spectrum
65 x 14.5 x 0.1 cm
Item no. ECO-GIT-350 (350 W)
81 x 14.5 x 0.1 cm
Item no. ECO-GIT-500 (500 W)

Prestige backrest for IR radiators

73.5 x 21 x 5 cm
Item no. HL-PR-IR-S (350 W)
88.5 x 21 x 5 cm
Item no. HL-PR-IR-L (500 W)

stainless steel bezel for IR radiators

Brushed stainless steel
Item no. VIT-BL-S (350 W) -
72.7 x 19.1 x 0.1 cm
Item no. VIT-BL-L (500 W) -
89.2 x 19.1 x 0.1 cm

Ergonomic backrest



Ergonomic VitaMy backrest
Removable, 2-part,
70 x 10.5 x 18 cm

Item no.
RL-IR-VM-L
(350 W, linden)



Ergonomic backrest
35 x 89 cm

Item no.
514-A (aspen)
514-D (red cedar)

Infra scented gel

Fragrant essences



Royal Eucament
Calming and harmonising,
cooling effect
Item no. A-300-RE (80 g)



Swiss pine
Cleansing, stimulating effect
Item no. A-300-ZI (80 g)



Lemon grass
Invigorating, relieves fatigue
Item no. A-300-ZG (80 g)



Use: Open the container and place it on a level surface. The gel automatically releases its fragrance. When the room is sufficiently fragrant, simply close the container again.



STEAM

STEAM GENERATORS

SENTIOTEC steam generators 88

SAWOTEC steam generators 89

ACCESSORIES

Steam bath fragrance emulsions 90

SENTIOTEC steam generators



4.5 – 15 kW 2 – 23 kW

The latest steam generators – extremely powerful and reliable steam units with connections for light (dimnable), ventilation and aroma pump.

Innovative technology:

- Evaporator output 4.5 kW, 6 kW, 9 kW, 11 kW, 15 kW
- Steam generators with digital operating unit
- Outer stainless steel casing
- Optional accessories available
- Remote start
- Child safety control
- Titanium heating elements for longer service life and less limescale
- Drip tray for deposits
- Automatic maintenance reminder
- one steam nozzle (ZG-500)



kW	Item no.
4.5	SGH-45
6	SGH-60
9	SGH-90
11	SGH-110
15	SGH-150



Datasheet

Optional accessories:

- Steam nozzle (ZG-500)
- Quiet steam nozzle (ZG-520)
- Aroma concentrate pump (ZG-900)
- Automatic outlet valve (ZG-700)
 - Fast cleaning: An automatic outlet valve is used for automatic water rinsing after operation of the steam generator. Limescale and dirt particles are rinsed out.



Item no.
ZG-500



Item no.
ZG-520



Item no.
ZG-700



Item no.
ZG-900

SAWOTEC steam generators

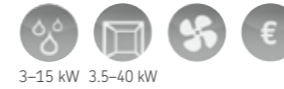

3–15 kW 3.5–40 kW

The latest steam generators – extremely powerful and reliable steam units with connections for light (dimnable), ventilation and aroma pump.

Innovative technology:

- Evaporator output 3.5 kW, 6 kW, 7.5 kW, 9 kW, 12 kW, 15 kW
- Stainless steel inner and outer casing
- More steam at the press of a button: The button (accessory) installed in the steam cabin can be used to trigger a steam burst, thereby increasing the amount of steam.
- Fast cleaning: With the Auto-Drain function, an automatic water rinse is triggered after operation of the steam generator to rinse away lime deposits and dirt particles.
- Comprehensive range of accessories available: Aroma pump, pushbutton for steam, etc.



kW	Item no.
3.5	STN-35-1/2-DFP-X
6	STN-60-C1/3-DFP-X
7.5	STN-75-C1/3-DFP-X
9	STN-90-C1/3-DFP-X
12	STN-120-3-DFP-X
15	STN-150-3-DFP-X

(control panel must be ordered separately)



Item no. STN-Inface-V2



Item no. STP-Inface-T
Touch



Datasheet

Optional accessories:

- Aroma pump (STP-PUMP)
- Illuminated fragrance button (STP-BTN)



Item no.
STP-PUMP



Item no.
STP-BTN

Steam bath fragrance emulsions

Fragrant scents

Steam bath fragrance emulsions enhance the sauna effect and are invigorating and refreshing.



Blood orange

Item no. A-120-BO (5 l)



Citrus lime

Item no. A-120-CL (5 l)



Eucamint

Item no. A-120-EM (5 l)



5 l



Eucalyptus

Item no. A-120-EU (5 l)



Pine needles

Item no. A-120-FN (5 l)



Lavender melissa

Item no. A-120-LM (5 l)





SOUND

<i>PRO D Bluetooth</i>	94
<i>Exciter & speaker</i>	94



LIGHT

<i>PRO D DMX</i>	96
<i>RGBW-DMX driver</i>	96
<i>RGBW range of lighting</i>	97
<i>LED remote control</i>	98
<i>RGBW wireless driver</i>	98
<i>LED coloured light</i>	99
<i>WW spotlight</i>	99
<i>RGBW LED overview</i>	100
<i>White LED overview</i>	101

PRO D Bluetooth



Datasheet

Hands-free

The Bluetooth music player with an integrated microphone for hands-free use and access to voice assistant (e.g. Siri, Google Now, etc.)

Innovative technology:

- Bluetooth 4.0 with a range of up to 30 m
- High-end amplifier for crystal-clear sound
- Simultaneous connection of up to 3 devices possible
- Suitable for the sauna interior



Item no.

PROD-BT-B

PROD-BT-W

Exciters



Datasheet

Structure-borne sound transducers:
An "invisible" music experience.

Innovative technology:

- Two 25 W electromagnetic exciters / structure-borne sound transducers
- Vibrations are transferred to the sauna wall/ceiling
- "Invisible" loudspeakers – no negative influence on the design
- Easy installation on the rear wall of the sauna or sauna ceiling with wood screws
- Temperature range: -25 °C to 70 °C
- Acoustics strongly dependent on the material, dimensions, and shape of the surface to be excited



Item no.

WC4-BT-EXC

Loudspeakers



Datasheet

Loudspeakers

Innovative technology:

- Two 20 W loudspeakers for ceiling mounting
- Heat and moisture-proof product
- Cut-out dimension: Ø 110 mm
- Suitable for the sauna interior
- Temperature range: -40 °C to 110 °C
- White-painted metal cover
- Easy installation with spring clips



Item no.

WC4-BT-SPK



PRO D DMX



The new PRO D DMX colour light control is an innovation for all the senses. Total relaxation through the latest technology!

Innovative technology:

- Suitable for RGBW LED tubes and spotlights via DMX driver
- Two colour light groups which can be operated separately or together
- Seven brightness levels
- Seven colours to choose from: white, purple, blue, turquoise, green, yellow, red
- Seven-speed colour changer
- Suitable for the sauna interior



Item no.

PRO-DMX

PRO-DMX-W



Datasheet

RGBW-DMX driver

- 2 versions:
 - > DMX CV 2 x 4-channel for 12 V/24 V RGBW tubes, power output 2 x 75 W
 - > DMX CC 2 x 4-channel for 350 mA RGBW spotlight, power output 2 x 25 W
- Universal DMX512 protocol, 8-bit RGBW
- 2 separately controlled outputs
- Straightforward setting of DMX addresses using rotary button
- Integrated, modifiable test programmes with colour change and much more
- Compatible with home.com4 sauna control unit



Item no.

DMX-CV

DMX-CC



Data sheet CV



Data sheet CC



RGBW range of lighting



The RGBW lighting range allows you to create your own individual coloured light experience and gives you unlimited options to design your sauna.

RGBW spotlight:

- LED 18 W, square 174 x 174 x 95 mm
- LED 5 W, round 90 x 90 mm (DxH) RGBW
- red / green / blue / warm-white (3000 K)
- Activated using 4 x 350 mA constant current, CC DMX driver
- High-quality aluminium and tempered glass
- Can be positioned directly above the sauna heater
- Suitable for steam baths and steam showers, IP65
- 2 m temperature-resistant connection cable
- Quick and easy assembly



Item no.

LED-SP-RGBW-18

LED-SP-RGBW-5



Datasheet



RGBW tube:

- Diameter: 19 mm
- 18 W per metre / 600 lumens per metre
- red / green / blue / warm-white (2800 K)
- Activated using 4 x 24 V constant current, CV DMX driver
- Temperature-resistant up to 95 °C
- Includes space-saving mounting clamps
- 3 m temperature-resistant connection cable
- Standard lengths: 0.5 m, 0.9 m, 1.2 m, 1.3 m, 1.4 m, 1.6 m and 1.8 m (special lengths available on request)
- Quick and easy assembly



Item no.

LED-TB-05

LED-TB-07

LED-TB-09

LED-TB-12

Item no.

LED-TB-13

LED-TB-14

LED-TB-16

LED-TB-18



Datasheet

LED power supply units:

- 3 versions:
 - > 40 W (for up to 2 m RGBW tube)
 - > 90 W (for up to 5 m RGBW tube)
 - > 160 W (for up to 9 m RGBW tube)
- Output voltage: 24 VDC
- Includes power supply and connection cable



Item no.

LED-PWS-24-40

LED-PWS-24-90

LED-PWS-24-160



LED remote control

- 2 versions:
 - > 1 zone (LR-1Z)
 - > 4 zone (LR-4Z)
- up to 4 different light groups
- Can be controlled individually and together
- Dimming
- 10 different programmes using Mode button, e.g.: Colour progression
- Speed of the colour progression can be set
- Warm white can be controlled and dimmed separately
- Several remote controls can be paired with each other
- Wall mount included



Item no.

LR-1Z

LR-4Z



Data sheet 1Z



Data sheet 4Z

RGBW wireless driver

RGBW wireless driver:

- 2 versions:
 - > LC-CV-VP 4-channel for 12 V/24 V RGBW tubes, power output 360 W
 - > LC-CC-VP 4-channel for 350 mA RGBW spotlight, power output 33.6 W
- Easy to connect the remote control using the ID learn button
- Compatible with sentiotec LED remote control



Item no.

LC-CV-VP

LC-CC-VP



Data sheet CV



Data sheet CC



LED coloured light



LED strips for individual and soft lighting of sauna and infrared cabin.

Innovative technology:

- Indirect lighting
- 12 RGB LEDs per strip
- Remote control
- Basic set: Remote control and 1 LED strip 495 mm (LED-FLS)
- Basic set expandable up to 10 strips (RGB-LED-495)
- Heat resistant: LED strips up to 125 °C
- Heat resistant: Remote control and power supply unit up to 60 °C
- Straightforward colour settings using colour ring
- Optional: 90 W transformer for up to 30 LED strips and 150 W transformer for up to 50 LED strips
- Custom colours, colour gradation or white light can be set
- Simple and flexible assembly



Item no.

LED-FLS

RGB-LED-495

WW spotlight



WW spotlight:

- LED 2 W, round 64 x 75 mm (DxH)
- LED 5 W, round 90 x 91 mm (DxH)
- Warm white (3000 K)
- Activated using 4 x 350 mA constant current, CC DMX driver
- High-quality aluminium and tempered glass
- Can be positioned directly above the sauna heater
- Suitable for steam baths and steam showers, IP65
- 2 m temperature-resistant connection cable
- Dimmable via 24 V
- Transformer included
- Quick and easy assembly
- Suitable for ceiling mounting



Item no.

LED-SP-WW-2W

LED-SP-WW-5W



Datasheet





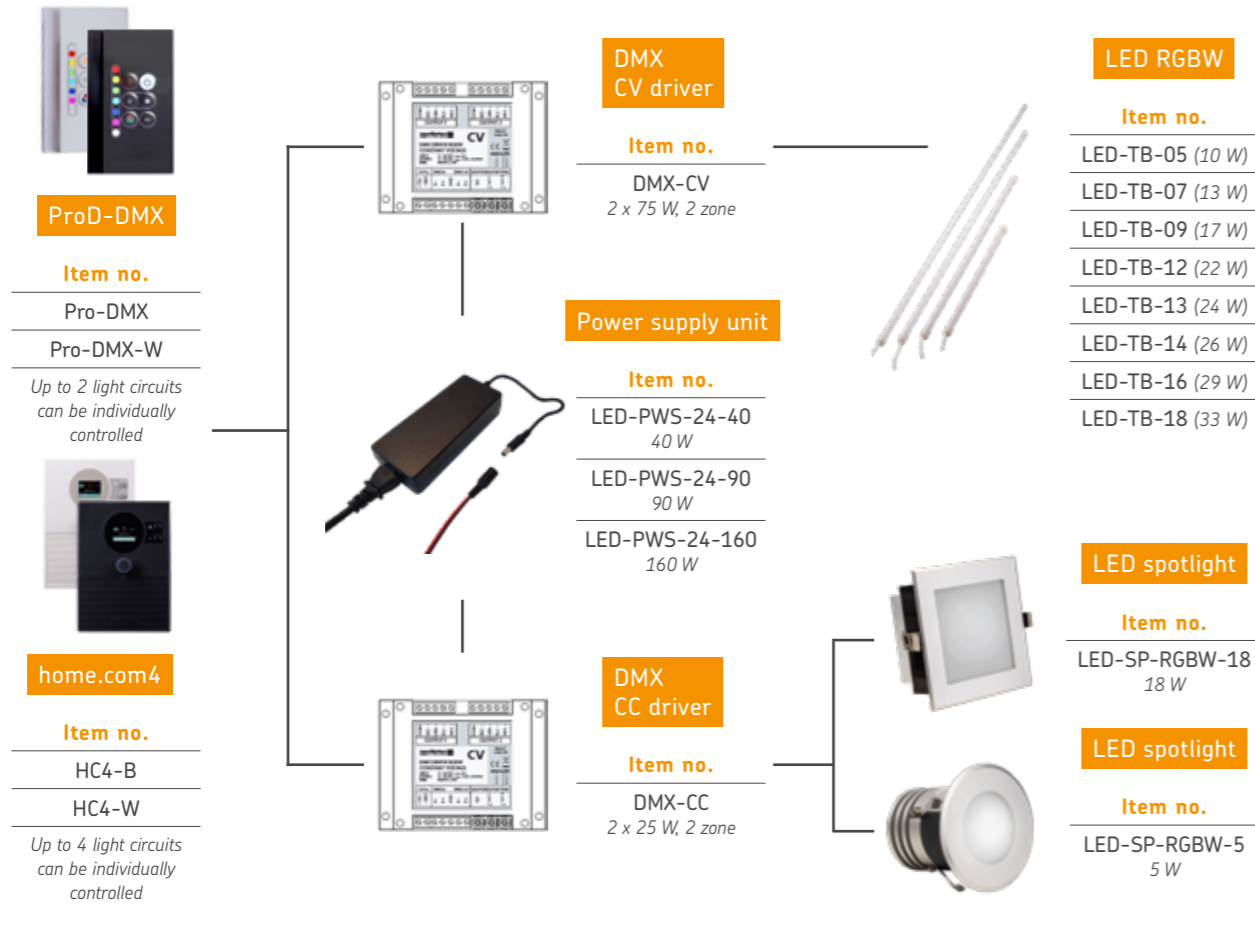



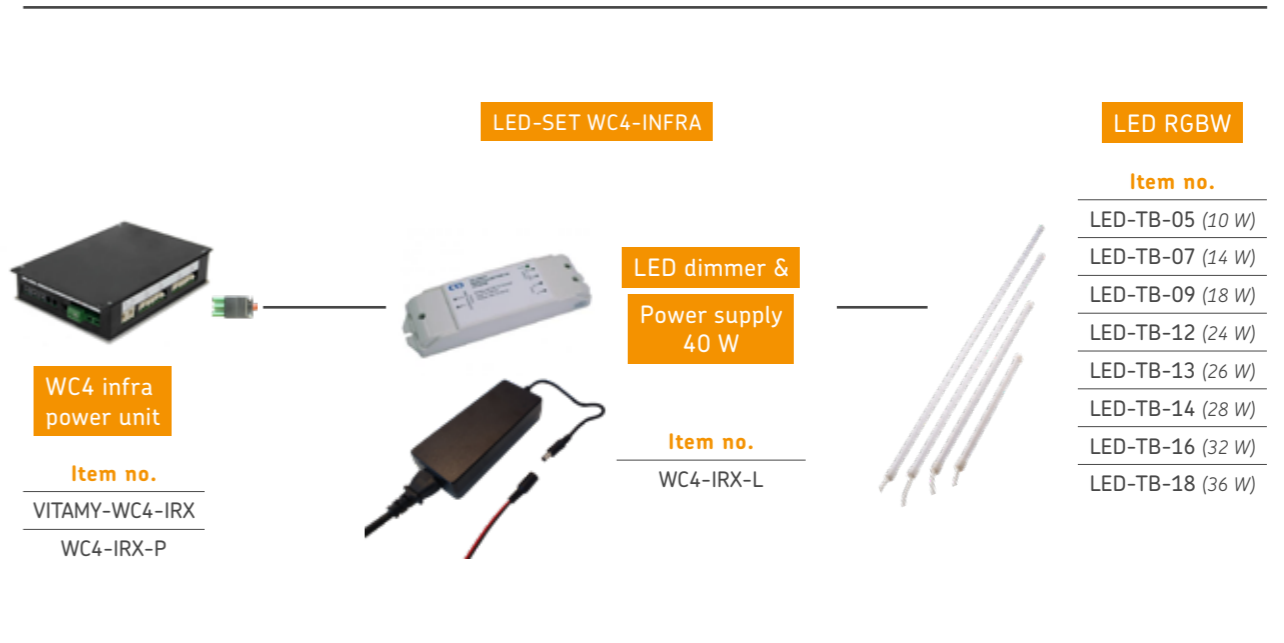
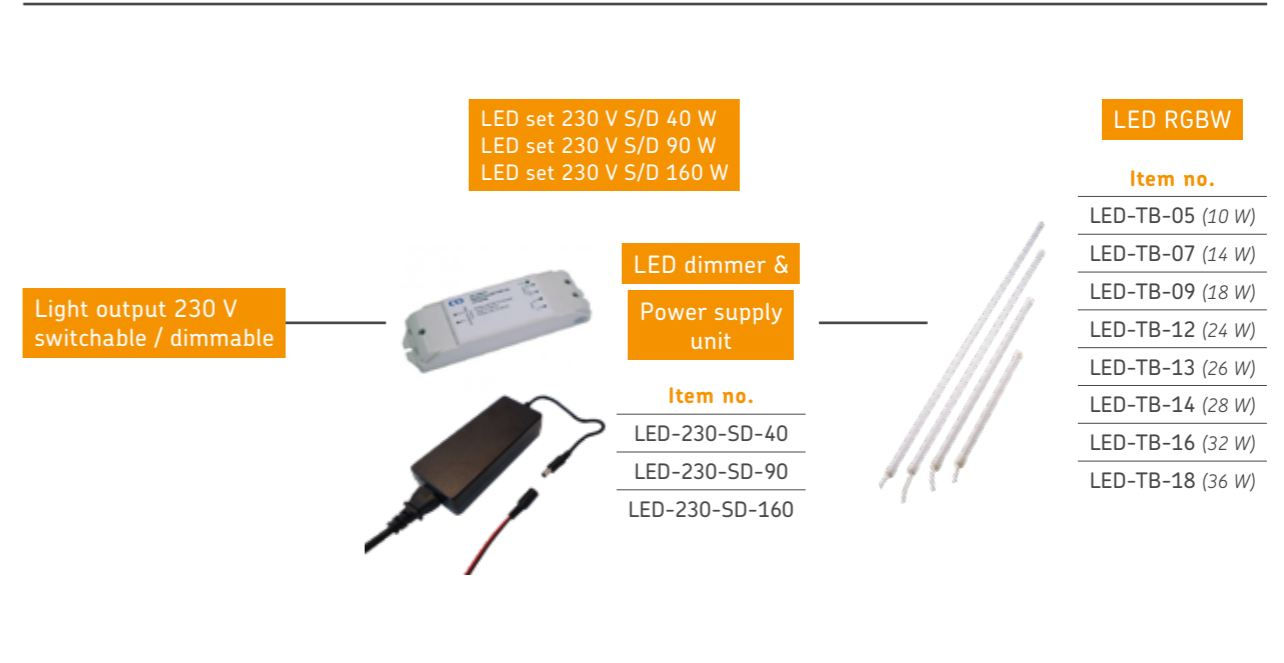
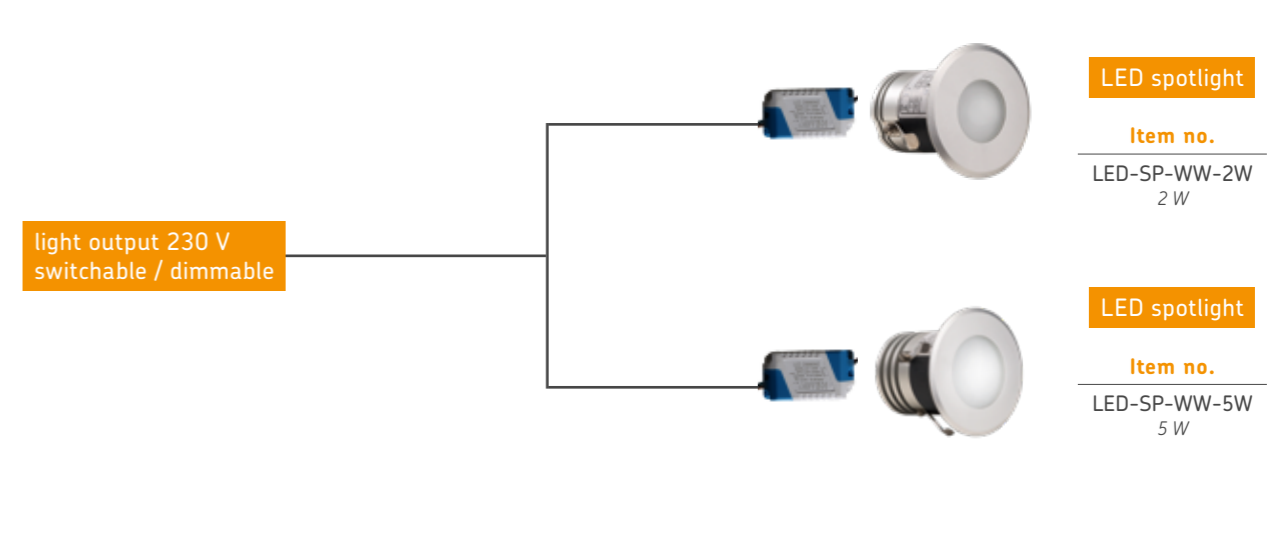













RGBW LED overview



White LED overview



Icon explanation

- | | |
|----------------------------------------------------------------------------------------------------------------------------------------------------------------------------------------|------------------------------------------------------------------------------------------------------------------------------------------------------------------------------|
|  Describes the maximum heating output for the connected sauna heater |  Specifies the quantity of stones that the heater can hold |
|  Describes the maximum evaporator output |  Specifies the size of the sauna cabin for which the control unit or the heater is designed |
|  Integrated control unit |  Specifies the operating voltage for the sauna heater |
|  Free-standing heater |  Wall-mounted heater |
|  The control unit is available in various housings |  Heating time limit – the control unit shuts down automatically after this number of hours |
|  The control unit offers a timer function that can be used, for example, to program the pre-set time |  Control unit with fan connection |
|  Control unit with remote activation |  The control unit is suitable for coloured light mode |
|  Describes the heating output of the connected infrared heating elements |  Control unit with music function |
|  IR red-light full-spectrum radiator |  WiFi |
|  Infrared radiator, dimmable | |
|  Affordable product | |
|  The control unit / the sauna heater is VDE-tested | |

Warranty conditions

sentiotec GmbH is convinced of the quality of its products, and we want you to benefit from them in the future!

Warranty conditions for technology

We provide a 2-year manufacturer's warranty on all of our control units in the sentiotec sauna, sentiotec infra and sentiotec light&media product lines. We provide a 2-year manufacturer's warranty for infrared radiators and additionally 5000 operating hours for DIR radiators. The warranty period for all sauna heaters is generally 2 years.

Requirement for this warranty:

- The control units have been installed by an authorised specialist company;
- the devices are operated according to the sentiotec operating manuals;
- the warranty claim is received by sentiotec within the warranty period.

Excluded from the warranty are:

- Deficiencies or damage caused by non-intended use;
- all consumable materials and consumable objects, such as heating elements, etc.

Warranty conditions for cabins:

We provide a five-year warranty on all of our solid wood and element cabins of the line sentiotec sauna and sentiotec infra for private usage. For commercial usage, the warranty is two years.

Requirement for this warranty:

- The corresponding invoice is presented,
- a detailed description of the defect is enclosed,
- the cabins were installed in accordance with the sentiotec installation and operating instructions,
- the warranty claim is received by sentiotec within the warranty period.
- In the case of outdoor cabins, care must be taken by the consumer to protect the wood by painting it or leaving it in with a wood protection paint.

Excluded from the warranty are:

- Deficiencies or damage caused by non-intended use,
- cabins that were modified without the explicit approval of the manufacturer,
- pitch pockets and pitch that has emerged,
- damage and discolouration of the wood due to inadequate ventilation or a non-intended installation site,
- natural changes in the wood such as discolouration, crack formation, shrinkage, swelling or similar changes due to the properties of the wood.

Pitch pockets are not grounds for return, since they can always appear in spruce wood and the depth at which they lie cannot be detected during the sorting out process. Pitch pockets are not grounds for return, if these are just under the surface, heat can cause them to soften and "bleed". Remove leaking pitch with a rag soaked in acetone. If only droplets of pitch occur, allow these to harden and then carefully scrape them off with a knife.

The warranty period starts from the date of invoice of the cabin manufacturer. A requirement is the presentation of the original invoice. If no original invoice is available, the month of manufacture, noted on the type plate of the product, is used as the basis for the start of the warranty period. The warranty period is neither extended nor renewed by warranty services.

sentiotec GmbH

Wartenburger Straße 31

4840 Vöcklabruck

AUSTRIA

T: +43 (0) 7672 / 229 00

F: +43 (0) 7672 / 229 00 - 80

info@harvia.com

www.sentiotec.com